



सत्यमेव जयते

Ministry of Housing and Urban Affairs  
Government of India

# FAECAL SLUDGE TREATMENT SYSTEMS DESIGN MODULE

## PART A: PRESENTATION SLIDES



## TITLE

Faecal Sludge Treatment Systems: Design Module (Part A: Presentation Slides)

## PUBLISHER

National Institute of Urban Affairs, New Delhi

## RESEARCH PROJECT

Sanitation Capacity building Platform (SCBP)

## GRAPHIC DESIGN

Deep Pahwa, Devender Singh Rawat, Bhavnesb Bhanot, Preeti Shukla

Copyright © NIUA (2021) Second Edition

Year of Publishing: 2021

## CONTENT

The module has been developed with the collaborative effort of NFSSMA partner organisations under Training Module Review Committee (TMRC) anchored by NIUA.

Editor	Authors	Contributor and reviewer
National Institute of Urban Affairs (NIUA)	National Institute of Urban Affairs Ecosan Services Foundation	National Faecal Sludge and Septage Management Alliance (NFSSMA)

## DISCLAIMER

While every effort has been made to ensure the correctness of data/information used in this training module, neither the authors nor NIUA accept any legal liability for the accuracy or inferences drawn from the material contained therein or for any consequences arising from the use of this material. No part of this module may be reproduced in any form (electronic or mechanical) without proper acknowledgement.



Copyright 2021 National Institute of Urban Affairs. This work is licensed under Attribution-ShareAlike 4.0 International. To view a copy of this license, visit <http://creativecommons.org/licenses/by-sa/4.0/>

## CONTACT

National Institute of Urban Affairs  
1st and 2nd floor Core 4B,  
India Habitat Centre,  
Lodhi Road, New Delhi 110003, India  
Website: [www.niua.org](http://www.niua.org), [scbp.niua.org](http://scbp.niua.org)  
E-Mail: [scbp@niua.org](mailto:scbp@niua.org)



सत्यमेव जयते

Ministry of Housing and Urban Affairs  
Government of India

# FAECAL SLUDGE TREATMENT SYSTEMS DESIGN MODULE

## PART A: PRESENTATION SLIDES

Collaborative Effort Under Training Module Review Committee (TMRC)



दुर्गा शंकर मिश्र  
सचिव  
**Durga Shanker Mishra**  
Secretary



भारत सरकार  
आवासन और शहरी कार्य मंत्रालय  
निर्माण भवन, नई दिल्ली-110011  
Government of India  
Ministry of Housing and Urban Affairs  
Nirman Bhawan, New Delhi-110011

### **FOREWORD**

Government of India launched Swachh Bharat Mission-Urban on 2<sup>nd</sup> October, 2014 to make country fully clean in five years and three other flagship Missions viz. Atal Mission for Rejuvenation and Urban Transformation (AMRUT), Smart City Mission (SCM) and Pradhan Mantri Awas Yojana-Urban (PMAY-U) were also launched on 25<sup>th</sup> June, 2015. These Missions aimed to promote sustainable and inclusive cities that provide core infrastructure and give a decent quality of life to its citizens, a green and clean environment and application of 'Smart' Solutions to make optimum utilization of resources.

Indian cities are faced with the twin challenges of managing their water demand and reducing waste water footprint. A paradigm shift is needed in favor of decentralized solutions for treatment of waste water and its reuse, promoting water harvesting and protecting our ecology. Several Indian cities are taking concrete initiatives to address this challenge. Success of achieving Open Defecation Free cities under Swachh Bharat Mission, has provided impetus for addressing safe treatment and disposal of septage waste.

National Faecal Sludge and Septage Management Policy-2017 of Govt of India, provided the policy framework for a paradigm shift in favor of decentralized and non sewerage sanitation systems for urban India. Seventeen States have adopted the National FSSM Policy and put in place their own State specific FSSM Policy. More than 440 towns across 10 states are installing decentralized septage treatment plants.

I am happy to share this set of 3 Training Modules (Orientation Module, Technology & Financing Module and Septage Treatment Systems Design Module) prepared by the National Institute of Urban Affairs (NIUA) and the National Faecal Sludge and Septage Management Alliance that will be useful for Urban Local Bodies officials and all para-statal technical agencies in planning and designing decentralized solutions. I hope the National and State level nodal training institutes of MoHUA and all other Urban Resource Centres, Universities, Colleges and autonomous bodies will find them useful for imparting conceptual and practical skills trainings to address the challenges of waste water and septage management.

These modules are made available on the **NIUA website: [scbp.niua.org](http://scbp.niua.org)** in downloadable PDF format for wide range and dissemination.

(Durga Shanker Mishra)

New Delhi  
02 October, 2019



# Acknowledgements

Increasing urbanization of India is putting significant pressure on the available water resources and the safe disposal of waste water. Most cities are facing increasing water stress and are breaching the limits to accessing drinking water from ground water, rivers and water bodies.

A paradigm shift is needed in the urban water and waste water sector, to move away from supply side to demand management and reducing the waste water footprint of cities. Septage management is one critical component of the urban sanitation challenge. With a grant from Gates Foundation, NIUA has rolled out a Sanitation Capacity Building Platform. Over the past 4 years, NIUA has promoted decentralized and non sewerred sanitation through capacity building, technical assistance, research and policy support to states and urban local bodies.

As member of the National Faecal Sludge and Septage Management Alliance(NFSSMA), NIUA has focused on capacity building of urban local body officials and engineers of para state technical agencies across 10 states of India. NIUA supported 8 nodal national training institutes of AMRUT for delivery of trainings and partnered with 9 universities to integrate concepts and technologies in their curriculum. NIUA supported the states of UP, Rajasthan and is currently working with Uttarakhand for appropriate urban sanitation solutions.

Through a collaborative engagement of the Training Modules Review Committee(TMRC) of NFSSM Alliance, anchored by NIUA, all training content developed so far on septage management, has been strategically revised updated into a 3 set learning Modules on Faecal Sludge and Septage Management :

- **One Day Orientation Module** provides an overview of septage management challenges, technology options and planning. Appropriate for all stakeholders.
- **Two Day Technology & Financing Options for FSSM Module** and exposure visit to a Septage Treatment Plant, is an excellent induction and orientation for Elected representatives, Urban Local Bodies officials and Engineers.
- **Three Day Faecal Sludge Treatment Systems Design Module** provides an in-depth training on twin aspects of Technology choice and Designing of Treatment Plants and Co Treatment of Septage with STPs. Appropriate for technical staff of ULBs, Para state agencies, consultants and private sector.

All the three Training Modules are in 2 parts : Presentations and Learning Notes. To serve as guidance for trainees as well as trainers. All the modules are also available on the NIUA website : [scbp.niua.org](http://scbp.niua.org)

The modules are produced as a collaborative engagement of NIUA and NFSSM Alliance Partner Organisations. NIUA acknowledges the support provided by Ecosan Services Foundation (ESF), Pune, CEPT University and All India Institute of Local Self Government (AIIILSG), Mumbai for developing the content for various modules. We acknowledge the support provided by Bill & Melinda Gates Foundation.

In the coming years, these modules will be developed into more innovative module formats including e learning and gamification, and new face to face training modules. Thereby addressing the next generation of septage management challenge of urban India.

**Hitesh Vaidya**  
Director, NIUA

### About National Faecal sludge and Septage Management Alliance (NFSSMA)

The 'NFSSM Alliance' was formed with a vision to "Create an enabling environment which amplifies scaling of safe, sustainable and inclusive FSSM through knowledge, partnerships and innovative solutions by 2024"

Convened by Bill and Melinda Gates Foundation in 2016, the Alliance is a voluntary body that aims to:

- Build consensus and drive the discourse on FSSM at a policy level, and
- Promote peer learning among members to achieve synergies for scaled implementation and reduce duplication of efforts

The Alliance currently comprises 32 organizations across the country working towards solutions for Indian states and cities. The Alliance works in close collaboration with the Ministry of Housing and Urban Affairs (MoHUA) and several state and city governments through its members to support the progress and derive actions towards mainstreaming of FSSM at state and a national level. The NFSSM Alliance works on all aspects of city sanitation plans to regulatory and institutional frameworks across the sanitation value chain. The NFSSM Alliance working in collaboration with the Ministry of Housing and Urban Affairs has been instrumental in the passage of India's First policy on FSSM launched in 2017. This resulted in 19 out of 36 states adopting guidelines and policies for FSSM in India.

The strength of the Alliance lies in its diverse membership, which includes research institutes, academic institutions, think-tanks, quasi-government bodies, implementing organizations, data experts, consultants, and intermediaries. This enabled a multi-disciplinary view of urban sanitation, with members building on each other's expertise. The Alliance has had enormous success in championing FSSM as a viable solution to the Government of India by broadly focussing on:

1. Influencing and informing policy
2. Demonstrating success through innovation and pilots
3. Building capacities of key stakeholders across the value chain

The collaborative continues to work towards promoting the FSSM agenda through policy recommendations and sharing best practices which are inclusive, comprehensive, and have buy-in from several stakeholders in the sector



### About Training Module Review Committee (TMRC)

To ensure quality control in content and delivery of trainings and capacity building efforts, a **Training Module Review Committee (TMRC)** was formed with the collaborative effort of all Alliance partners. TMRC which is **anchored by National Institute of Urban Affairs (NIUA)**, has the following broad objectives:

- Identification of priority stakeholders and accordingly training modules for Capacity Building
- Development of a Normative Framework–For Capacity Building at State Level
- Standardization of priority training modules–appropriate standardization of content with flexibility. for customization based on State context
- Quality Control of Trainings–criteria for ensuring minimum quality of training content and delivery
- Strategy for measuring impact of trainings and capacity building efforts

## About the Training Module

<b>Title</b>	Faecal Sludge Treatment Systems: Design Module (Part A: Presentation Slides)
<b>Purpose</b>	<p>This module is designed to give the participants a detailed understanding of designing a Faecal Sludge and Septage (FSS) treatment system/plant, including conveyance and financial considerations.</p> <p>With the extension of AMRUT, the announcement of SBM-U 2.0 and AMRUT 2.0, and the recommendations of the 15th Finance Commission, this course provides participants a detailed understanding of implementing FSSM, which is a key component in these national missions.</p>
<b>Target Audience</b>	The module is designed for professionals, consultants and PMUs of missions, experts, practitioners and government officials who are having an engineering background and professional experience in wastewater and septage management.
<b>Learning Objectives</b>	<p>The module aims to convey the following learning:</p> <ul style="list-style-type: none"> <li>• Understanding characteristics and methods of quantifying faecal sludge and septage (FSS)</li> <li>• Financial viability and planning of regular desludging of on-site sanitation systems such as septic tanks, at town level</li> <li>• Understand the FSS treatment principles, for mechanized and non-mechanized treatment technologies in different context/geographies.</li> <li>• Develop a know-how of different design aspects such as treatment technologies, siting and layout planning, and operation and maintenance of a treatment plant</li> </ul>
<b>Format of the Module</b>	<p>The Module has the following three parts:</p> <p><b>Part A – Presentation slides: Contains the PowerPoint presentations and practical exercises that trainees can refer to during the training sessions and exercise work</b></p> <p>Part B – Learning Note: Identifies the learning objectives and key learning outcomes that can guide trainers and trainees. Key learning outcomes are defined as specific points for each session, which need to be limited</p> <p>Part C - Workbook: This contains the exercise developed for training based on the real-life cases.</p>
<b>Duration</b>	The advanced technical training is proposed to be conducted in four days. It could be extended by another day depending on the size of a batch of trainees and their interest and time given for all the sessions.

## AGENDA

Time Duration	Session Title
<b>Day 1</b>	
9.30 - 10.00 hours	Introduction of participants Ground rules Understanding the objectives of the training
10.00 - 10.45 hours	Introduction to Faecal Sludge and Septage Management and its importance and need
<b>10.45 - 11.00 hours</b>	<b>Tea and Coffee Break</b>
11:00 - 11.45 hours	Quantification of Faecal Sludge and Septage
11:45 - 12:30 hours	Characterisation of Faecal Sludge and Septage Management
<b>12:30 - 13:30 hours</b>	<b>Lunch Break</b>
13:30 - 14:15 hours	Containment Systems: Sources of Faecal Sludge and Septage
14:15 - 15:00 hours	Emptying and Conveyance of Faecal Sludge and Septage
<b>15:00 - 15:15 hours</b>	<b>Tea and Coffee Break</b>
15:15 - 16:00 hours	Exercise- Assets for emptying and conveyance of the Faecal Sludge and Septage
16:00 - 16:30 hours	Key take away Feedback Wrap up

Time Duration	Session Title
<b>Day 2</b>	
10:00 - 10:45 hours	Treatment Mechanism for Faecal Sludge and Septage
10:45 - 11:00 hours	Tea and Coffee Break
11:00 - 11:45 hours	Selection of Treatment components
11:45 - 12:45 hours	Formation of Faecal Sludge and Treatment Technology
12:45 - 13:30 hours	Lunch Break
13:30 - 14:15 hours	Design of Solid Liquid Separation Unit: Settling Thickening Tank
14:15 - 15:00 hours	Design of Stabilization Unit: Anaerobic Digester
15:00 - 15:15 hours	Tea and Coffee Break
15:15 - 16:00 hours	Design of Dewatering Unit: Unplanted Drying Bed
16:00 - 16:30 hours	Key take away Feedback Wrap up

Time Duration	Session Title
<b>Day 3</b>	
10:00 - 11:00 hours	Faecal Sludge and Septage Receiving Station
<b>11:00 - 11:15 hours</b>	<b>Tea and Coffee Break</b>
11:15 - 12:00 hours	Preliminary Treatment: Screening and Grit Removal Unit
12:00 - 13:00 hours	Mechanised Dewatering Unit: Screw Press, Belt Press
<b>13:00 - 14:00 hours</b>	<b>Lunch Break</b>
14:00 - 14:45 hours	Mechanised Drying Unit
14:45 - 15:30 hours	Mechanised Thermal Unit
<b>15:30 - 15:45 hours</b>	<b>Tea and Coffee Break</b>
15:45 - 16:30 hours	Construction, Quality control and Commissioning of a Faecal Sludge and Septage Treatment Plant
16:00 - 16:30 hours	Key take away Feedback Wrap up

Time Duration	Session Title
<b>Day 4</b>	
10:00 - 11:00 hours	Operation and Maintenance at a Faecal Sludge and Septage Treatment Plant
<b>11:00 - 11:15 hours</b>	<b>Tea and Coffee Break</b>
11.15 - 13.00 hours	Faecal Sludge Treatment Plant: Site identification, Components of an FSTP, Layout planning
<b>13:00 - 14:00 hours</b>	<b>Lunch Break</b>
14.00 - 14.45 hours	Liquid Treatment Systems and their suitability
14.45 - 15.30 hours	Financial aspects in FSSM
<b>15:30 - 15:45 hours</b>	<b>Tea and Coffee Break</b>
15.45 - 16.30 hours	Exercise on financial calculations for FSTP
16:00 - 16:30 hours	Key take away Feedback Wrap up



# Contents

<b>Session 1: Introduction to Operationalising Faecal Sludge &amp; Septage Management</b>	<b>1</b>
1. Sanitation Facts: India	5
2. National Programs, Policies & Acts	7
3. Introduction to FSSM	11
4. What is Faecal Sludge & Septage?	15
5. Sanitation Value Chain	16
6. Needs & Challenges in Sanitation System	16
<b>Session 2: Quantification of Faecal Sludge &amp; Septage</b>	<b>23</b>
1. Why quantification is necessary?	25
2. Sludge Production Method	27
3. Sludge Collection Method	28
<b>Session 3: Characterization of Faecal Sludge &amp; Septage</b>	<b>33</b>
1. Parameters	36
2. Comparison of different types of sludge based on sources	37
3. Characterization ratios	40
4. Operational Factors	40
<b>Session 4: Containment Systems: Sources of Faecal Sludge &amp; Septage</b>	<b>43</b>
1. Containment Units	45
2. Types of Containment Units	46
<b>Session 5: Emptying &amp; Conveyance of Faecal Sludge &amp; Septage</b>	<b>53</b>
1. Types of Collection & Transportation techniques	55
2. Manually Operated Mechanical Equipment	56
3. Motorized Emptying	59
4. Transfer Station	66
5. Dewatering Trucks	69
<b>Session 6: Treatment Mechanism for Faecal Sludge &amp; Septage</b>	<b>71</b>
1. Treatment Targets	73
2. Physical Mechanisms	75
3. Biological Mechanisms	78
4. Chemical Mechanisms	81
5. Treatment Concerns	82

<b>Session 7: Selection of Faecal Sludge &amp; Septage Treatment Mechanisms</b>	<b>85</b>	<b>Session 15: Mechanized Drying Units</b>	<b>157</b>
1. Treatment Objectives	87	1. Introduction	160
2. Approaches for FSSM	90	2. Solar Drying	161
3. Selection of Treatment Mechanisms	92	3. Thermal Drying	163
<b>Session 8: Formation of Faecal Sludge &amp; Septage Treatment Technologies</b>	<b>97</b>	<b>Session 16: Mechanized Thermal Treatment</b>	<b>169</b>
1. Stages & Mechanisms of FSS Treatment	99	1. Introduction to Thermal Treatment	171
2. Natural FSS Treatment Units	101	2. Incineration	172
3. Case Studies	105	3. Pyrolysis	175
<b>Session 9: Designing of Solid Liquid Separation Unit: Settling Thickening Tank</b>	<b>109</b>	<b>Session 17: Construction of Faecal Sludge &amp; Septage Treatment Plant</b>	<b>179</b>
1. Concept	111	1. Contract Documentation	181
2. Designing	111	2. Site Supervision	182
3. Operation & Maintenance	112	3. Construction Aspects	182
<b>Session 10: Designing of Stabilization Unit: Anaerobic Digester</b>	<b>113</b>	4. Commissioning Plans	185
1. Concept	115	5. Pre-Commissioning Tests	185
2. Design Parameters	116	6. Wet Commissioning	187
3. Designing	116	7. Process Commissioning	188
4. Operation & Maintenance	118	8. Process Performance Tests	189
<b>Session 11: Designing of Dewatering Unit: Unplanted Drying Bed</b>	<b>119</b>	9. Handover Documentation	189
1. Concept	121	<b>Session 18: O &amp; M of Faecal Sludge &amp; Septage Treatment Plant</b>	<b>191</b>
2. Design Parameters	121	1. Integrating O & M with planning & designing	193
3. Construction	122	2. O & M Planning	196
4. Design	122	3. Monitoring & Record Keeping	199
5. Operation & Maintenance	123	<b>Session 19: Siting, Layout Planning &amp; Safety Planning of Faecal Sludge &amp; Septage Treatment Plant</b>	<b>203</b>
<b>Session 12: Faecal Sludge &amp; Septage Receiving Station</b>	<b>125</b>	1. Siting of FSTP	205
1. Receiving Station	127	2. Layout Planning	207
2. Dumping station	129	3. Safety Planning	214
3. Odour control unit	131	<b>Session 20: Liquid Effluent Treatment of Faecal Sludge &amp; Septage Treatment Plant</b>	<b>217</b>
4. Types of Receiving Station	132	1. Purpose & Goal of Wastewater Treatment	219
<b>Session 13: Preliminary Treatment of Faecal Sludge &amp; Septage</b>	<b>135</b>	2. Wastewater Treatment Basics	220
1. Screening	137	3. Primary Treatment	221
2. Grit Removal	141	4. Secondary Treatment	223
<b>Session 14: Mechanized Dewatering Units</b>	<b>145</b>	5. Tertiary Treatment	228
1. Introduction	147	6. Treatment Chain	229
2. System Description	148	<b>Session 21: Financial Aspects of Faecal Sludge &amp; Septage Management</b>	<b>233</b>
3. Performance	149	1. Financial Aspects	235
4. Operation & Design Considerations	150	2. Desludging and Financial Flow Models	238
5. Comparison: Screw Press v/s Belt Filter Press	151		
6. Design Criteria & Procedure	152		
7. Exercise	155		

Session

**01**

**Introduction to  
Operationalising Faecal  
Sludge & Septage  
Management**

---

## Learning Objectives

In this session we will primarily understand why non sewered sanitation is important for India and how it can be operationalised in towns and cities.

We will also see key components of the non sewered sanitation and understand holistic management of these components.

## Contents

- Sanitation facts – INDIA
- National programs and policies
- What is Faecal Sludge and Septage ?
- Sanitation Value Chain
- Need and Challenges in FSSM



What does the picture depict? Can you pinpoint certain things and draw inference from the picture?

The person seems to be well to do, yet he is resorting to open defecation in the fields. Lower access to toilet is not the result of poverty but it is the way of life for certain people. Behavioral practices and strong IEC campaigns are required in order to achieve ODF in real sense.



What does the picture depict? What kind of toilet is it? Who is the person in the picture? What is his job? Does he have the right equipment to do his job? Is his health at risk by doing this job? Will you use this toilet? If no, then why?

Having access to sanitation infrastructure as the one shown in picture is one thing; however, maintaining it and keeping it in proper working condition helps to achieve the real goal of ODF. Without proper operation and maintenance of the sanitation infrastructure, it is very difficult to reach to the ultimate objective of practicing good sanitation.

## 1. Sanitation Facts: India

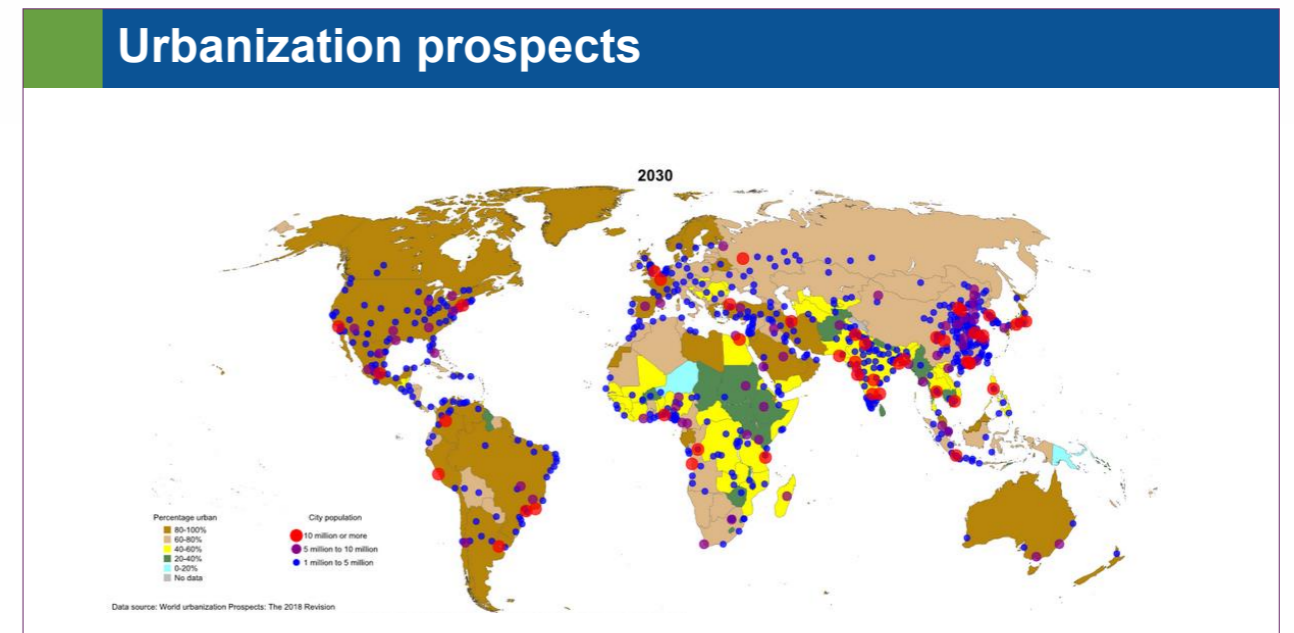

This slide shows the pace at which India has undergone urbanization as compared to other countries in the world. Although, India will have less percentage of the population living in urban centers, it will host to host to many cities having population more than 10 million. The pace at which the urban centers are experiencing population explosion, it is very difficult to provide adequate municipal services such as drinking water, access to toilet and safe management of solid and liquid waste. Add to this the population migrating from the rural to urban centers in search of better employment opportunities puts more stress in the infrastructure.

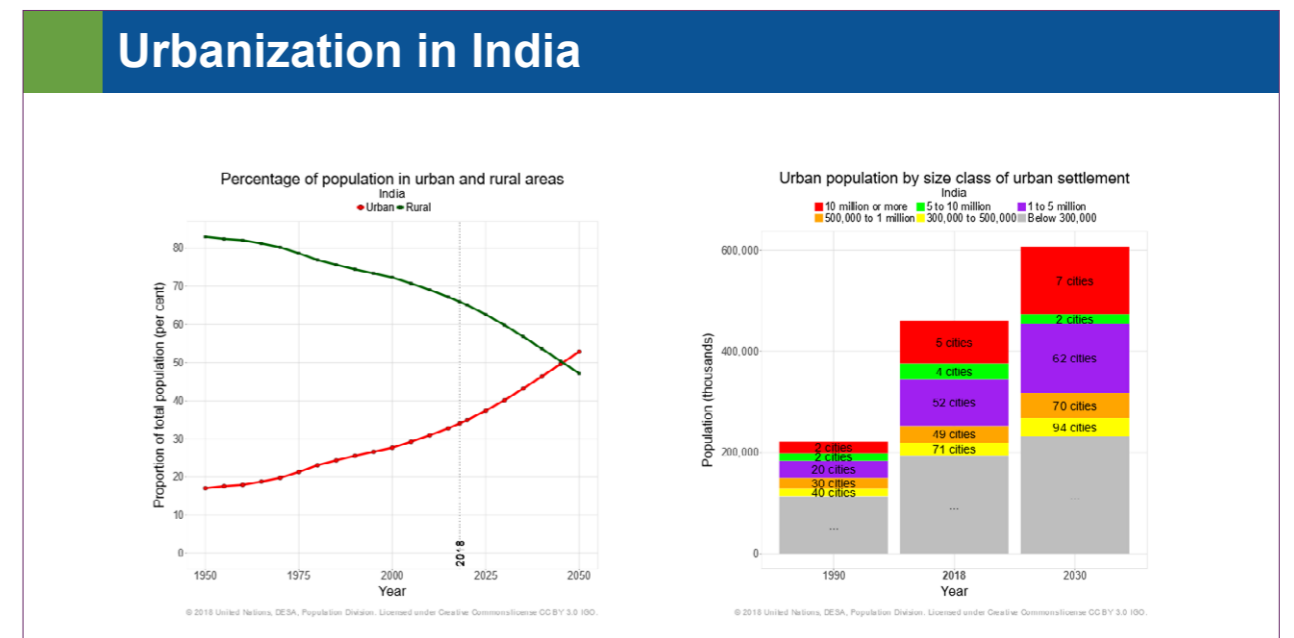

The graph on the left shows that percentage of population residing in the rural areas is decreasing and by 2045, more than 50% of the population in India will be living in urban areas. It is expected that in less than a decade, India will have seven cities with more than 1 crore population and 62 and 70 cities with population between 10 to 50 lakh and 5 to 10 lakhs respectively.

## Sanitation facts – INDIA (2011 census)

- 18.6% urban HHs have **NO TOILETS!**
- 32.7% of urban HHs have access to **PIPED SEWER!**
- 38.2% HHs are connected to **SEPTIC TANKS.**
- 6% of HHs depend on **COMMUNITY TOILET!**



According to the Census of 2011, less than 20% of urban households had no access to toilets. However, only 33% of households were connected to sewers and 38% were connected to septic tanks. These numbers might seem to be okay, but taking a comprehensive look at the status of sanitation in urban India reveals something different.

## Status of Sanitation in Urban India

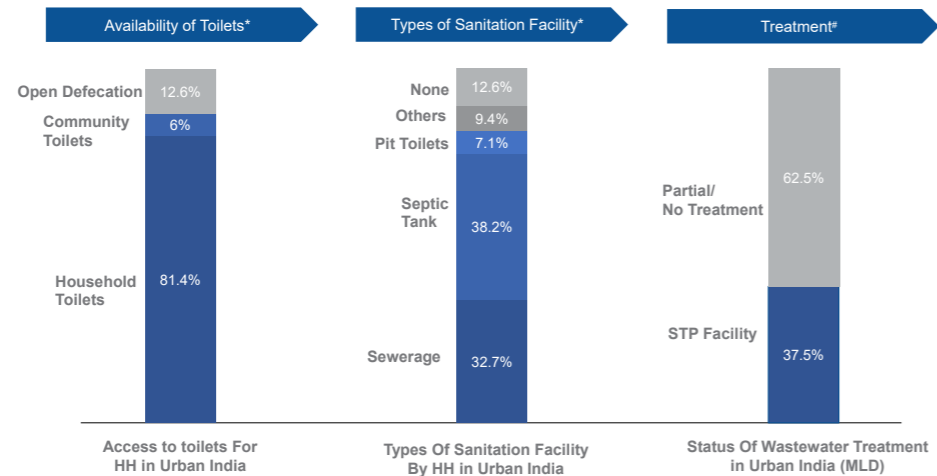

The percentage might be deceiving, but when we calculate the absolute numbers, the picture is horrifying:

- 37 million people practice open defecation in urban India.
- 28 million people with individual toilets use insanitary methods of disposal of waste.
- 43,117 MLD of untreated wastewater is discharged in water bodies or on land.

## 2. National Programs, Policies & Acts

### Prohibition of Employment as Manual Scavengers and their Rehabilitation Act & Rules, 2013

- Terminologies
  - **Manual Scavenger** – manual cleaning, carrying & disposal of human excreta from latrines, pits, septic tanks, drains, sewers.
  - **Hazardous cleaning** – cleaning without proper use of cleaning devices, protective gear.
  - **Protective gear** – safety equipment and personal gear to avoid direct exposure to hazardous substance or injury while cleaning work.
- Prohibition of insanitary latrines, Identification of manual scavengers and their rehabilitation
- **Roles and responsibilities** of employers and procedures to be followed
- Manual scavenging is **non bailable and cognizable offence**
- **Penalty**
  - First contravention – up to 2 years of jail and/or up to 2 lakhs fine
  - Subsequent contravention - up to 5 years of jail and/or up to 5 lakhs fine



As per the Manual Scavenging Act 2013, the hazardous cleaning by an employee, in relation to a sewer or septic tank, means its manual cleaning by such employee without the employer fulfilling his obligations to provide protective gear and other cleaning devices and ensuring observance of safety precautions, as may be prescribed or provided in any other law, for the time being in force or rules made thereunder. The act, prohibits the insanitary toilets and directs for the identification of manual scavengers and their rehabilitation. It also mentions the roles and responsibilities of employers and procedures to be followed during septic tank or sewer lines.

## Swachh Bharat Mission (SBM) 2.0



### Objectives:

- 1 All statutory towns will be ODF+ certified
- 2 All statutory towns (below 1 lakh population) will be ODF++ certified
- 3 50% statutory towns (below 1 lakh population) will be Water+ certified
- 4 All statutory towns will be atleast 3-star Garbage Free Rated
- 5 Bioremediation of all the legacy dumpsites

### Key Focus of SBM 2.0:

- ❑ **Complete FSM** and wastewater treatment,
- ❑ **Source segregation** of waste,
- ❑ **Reduction in single use plastic,**
- ❑ **Reduction in air pollution,** and
- ❑ **Bioremediation** of all legacy dumpsites.

Applicable to all the cities

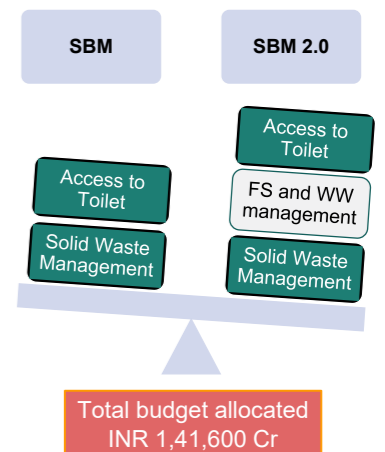

**Swachh Bharat Mission (SBM)** was launched in the year 2014 to eliminate open defecation and improve solid waste management. In first phase, it had aimed to achieve 100% ODF status for Urban and Rural areas by 2nd Oct 2019. The objectives of the first phase of the mission also included eradication of manual scavenging, generating awareness and bringing about a behaviour change regarding sanitation practices, and augmentation of capacity at the local level. The second phase of the mission (SBM 2.0) aims to sustain the open defecation free status and improve the management of solid and liquid waste. The mission is aimed at progressing towards target 6.2 of the Sustainable Development Goals (SDGs) established by the United Nations in 2015.

In continuation to SBM(U), the Ministry of Housing and urban Affairs launched SBM(U) 2.0 in 2021 with a focus on complete faecal sludge management, waste water treatment, source segregation of garbage, reduction in single use plastic, reduction in air pollution by effectively managing waste from construction and demolition activities, and bio-remediation of all legacy dumpsites.

## Open defecation free



**ODF**



- At any point of the day, not a single person is found defecating in the open

**ODF+**

- All CTs and PTs are functional and well maintained

**ODF++**

- Faecal sludge/septage and sewage is safely managed and treated

Subsequent to the introduction of Manual Scavenging Act, Government of India in 2014 took up a huge task of eliminating open defecation in India. In terms of percentage, the number might be misleading, but back in 2014 the absolute number of persons practicing open defecation was huge. Swachh Bharat Mission was launched and one of its focus was making urban and rural habitation open defecation free (ODF). To do this the policy specifically mentioned that all households should have access to toilets in the form of Individual Household Toilet (IHHL) or a Community Toilet (CT). It also mentioned that all the insanitary latrines- toilet having single pits or which are directly connected to drains should be converted into sanitary toilets by linking them to twin pits (soak pit) or a septic tank.

Creating infrastructure in the form of toilet and containment system is one part, however soon the government realized that maintenance of the infrastructure is also equally important if one needs to realize the ultimate of becoming of sustaining ODF status. This was termed as ODF +. At the same time, it was also realized that without the management of the waste originating from the households and containment units the objective of sanitation cannot be ensured. Hence ODF ++ was concept was brought forward, which said that faecal sludge, septage and sewage should also be safely managed at the local government level.

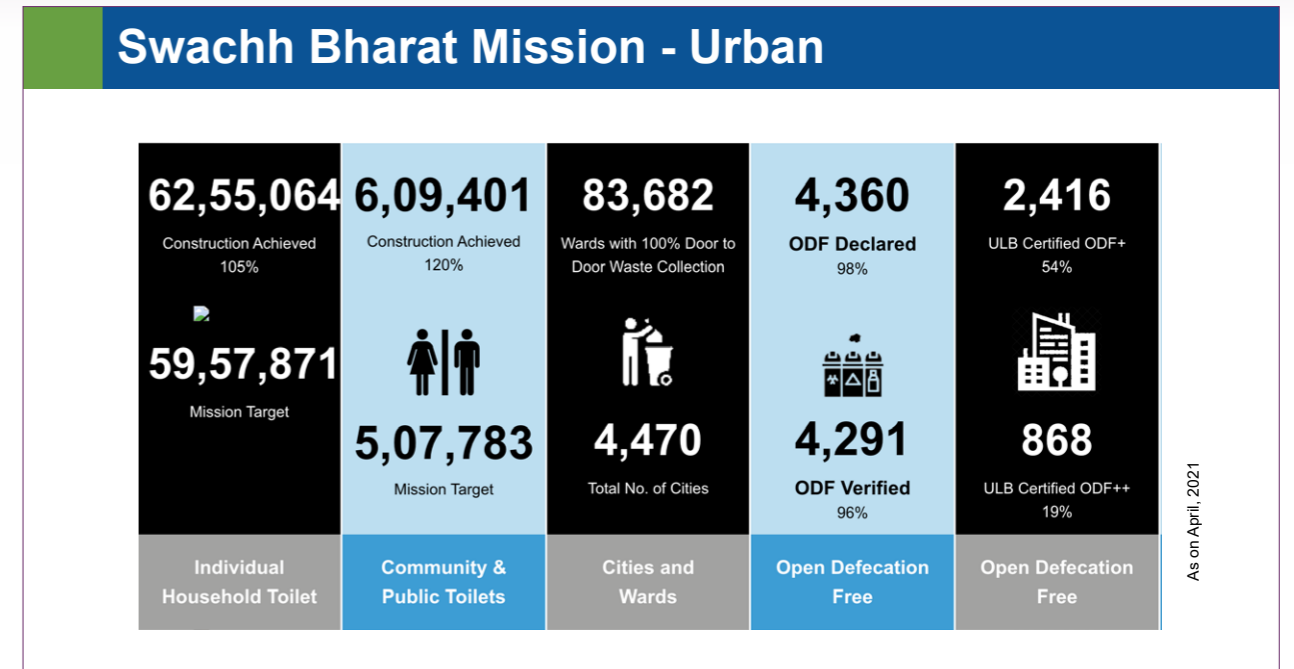

The total number of Individual Households Toilets built until April 2021 were approximately 59.57 lakhs, community and public toilet built were approximately 6.09 lakhs and total cities which have been declared ODF were 4360.

## AMRUT 2.0

Key focus is on **strengthening water security of the cities.**

500 AMRUT towns to achieve 100% treatment of sewerage and septage

4800 ULBs achieve 100% coverage of water supply

Applicable to all cities

20% Water demand met through reuse of water

Total budget allocated  
INR 2,77,000 Cr

Source: Operational Guidelines AMRUT 2.0 Oct, 2021

Objectives:

Rejuvenation of water bodies

Promoting circular economy of water

Conduct Pey Jal Survekshan

Initiate an IEC campaign about conservation of water

Start a technology sub-mission for water

Protecting fresh water bodies from getting polluted

Promoting digital economy- Paperless Mission

Promoting Public Private Partnerships (PPP)

AMRUT 2.0 is a new initiative of Ministry of Housing and Urban Affairs launched in 2021 which focuses primarily on providing universal coverage of water supply to all urban households. Under AMRUT 2.0, the estimated gap of 2.68cr household taps and 2.64cr sewer connections/septage in 500 AMRUT cities is proposed to be covered.

Its key objectives are:

- To ensure the rejuvenation of water bodies and urban aquifer management will be undertaken to augment sustainable fresh water supply.

- To promote circular economy of water through development of city water balance plan, focusing on recycle/reuse of treated sewage, rejuvenation of water bodies and water conservation. 20% of water demand to be met with reused water by development of institutional mechanism.
- To start a technology sub-mission for water that will leverage latest global technologies in the field of water.
- To initiate an IEC campaign to spread awareness among masses about conservation of water.
- To conduct Pey Jal Survekshan to ascertain equitable distribution of water, reuse of wastewater and mapping of water bodies with respect to quantity and quality of water through a challenge process.
- To protect fresh water bodies from getting polluted to make natural resources sustainable.
- Cities having million plus population to take up PPP projects worth minimum of 10% of their total project fund allocation which could be on Annuity/ Hybrid Annuity / BOT Model.

In addition to the key objectives, the mission has a reform agenda having focus on strengthening of urban local bodies and water security of the cities. Major reforms are reducing non-revenue water to below 20%; recycle of treated used water to meet at least 20% of total city water demand and 40% for industrial water demand at State level; dual piping system; unlocking value and improving land use efficiency through proper master planning; improving credit rating & accessing market finance including issuance of municipal bonds and implementation Online Building Permission System under EoDB.

The Mission also seeks to promote AatmaNirbhar Bharat through encouraging Start-ups and Entrepreneurs with an aim to promote GIG economy and on-boarding of youth & women.

## Programs

### Atal Mission for Rejuvenation and Urban Transformation (AMRUT)

Objectives:

- Providing basic services (e.g. water supply, sewerage, septage management, urban transport) in the city
- To ensure that every household has access to a tap with the assured supply of water and a sewerage connection
- Increase the amenity value of cities by developing greenery and well-maintained open spaces
- Reduce pollution by switching to public transport or constructing facilities for non-motorised transport

### Smart Cities Mission

Objectives:

- Providing core infrastructure such as water supply, electricity, sanitation, solid waste management, mobility, housing, etc.
- Provide clean and sustainable environment

The focus is on:

- Application of smart solutions
- Sustainable and inclusive development

**The Atal Mission for Rejuvenation and Urban Transformation (AMRUT) mission** was initiated in June 2015 which aimed to provide the basic utility services (e.g. water supply, sewerage, septage management, urban transport) to households and build amenities in cities which will improve the quality of life for all. The purpose of Atal Mission for Rejuvenation and Urban Transformation (AMRUT) is to ensure that every household has access to a tap with the assured supply of water and a sewerage connection, to increase the amenity value of cities by developing greenery and well-maintained open spaces (e.g. parks) and to reduce pollution by switching to public transport or constructing facilities for non-motorized transport (e.g. walking and cycling). All these outcomes are valued by citizens, particularly women, and indicators and standards have been prescribed by the Ministry of Housing and Urban Affairs (MoHUA) in the form of Service Level Benchmarks (SLBs).

## Policies and Guidelines

### National Policy on FSSM

- Leveraging FSSM to achieve 100% access to safe sanitation
- Achieving integrated citywide sanitation
- Sanitary and safe disposal
- Awareness generation and behavior change

### SBM ODF+ and ODF++ Framework

- Septic tanks as per IS Code 2470 to have soak pit
- Cluster approach for co-treatment
- Bylaws mandatory for desludging frequency of 3 years in ULB
- Adequate emptying and conveyance equipment
- Sustainable financial model
- Safe practices for desludging



**National Faecal Sludge and Septage Management (FSSM) Policy** was released in 2017 to set the context, priorities, and direction for and to facilitate, nationwide implementation of FSSM services in all ULBs such that there will be safe and sustainable sanitation approach at city level. The key objective of the policy is to mainstream the FSSM in urban India by 2019 and ensure that the all benefits of wide access to safe sanitation accrue to all citizens across the sanitation value chain with containment, extraction, transportation, treatment, and disposal / re-use of all faecal sludge, septage and other liquid waste and their by-products and end-products. Another objective of the policy is to enable and support synergies among relevant central government programs such as SBM, AMRUT and the Smart Cities Mission to realise safe and sustainable sanitation for all. The FSSM policy expects to mitigate gender-based sanitation insecurity directly related to FSSM, reducing the experience of health burdens, structural violence, and promote involvement of both genders in the planning for and design of sanitation infrastructure.

## Swachh Survekshan 2021

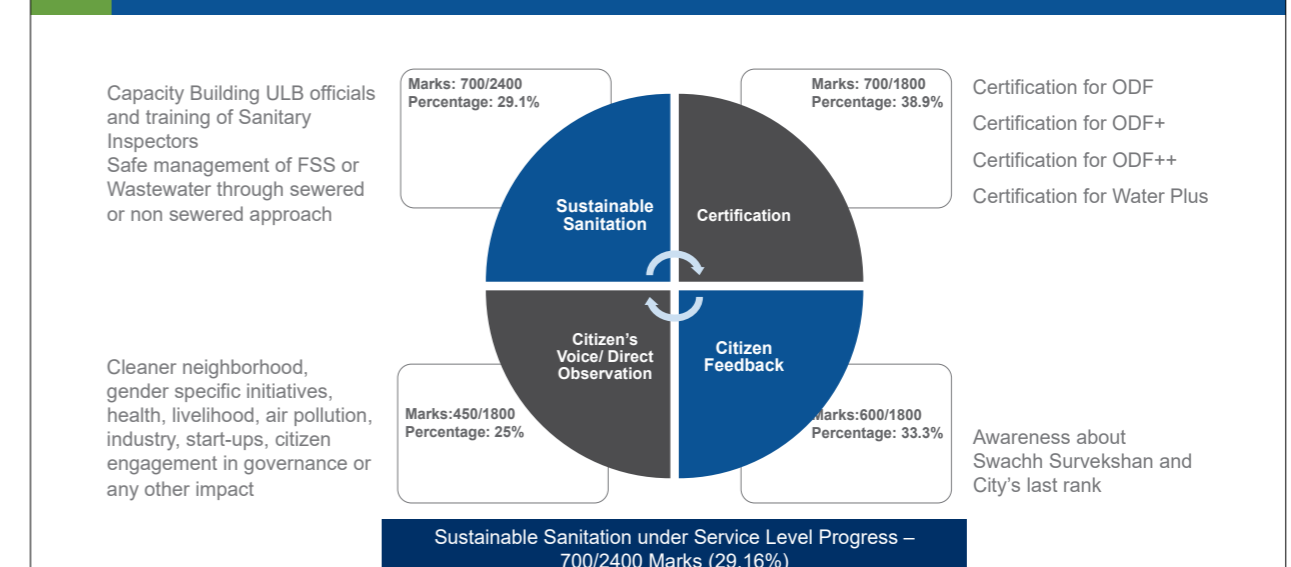

The Government of India also validated that work done under the flagship program of Swachh Bharat Mission and AMRUT through Swachh Survekshan. Swachh Survekshan also included parameters pertaining to FSSM as shown in the diagram above.



### 3. Introduction to FSSM

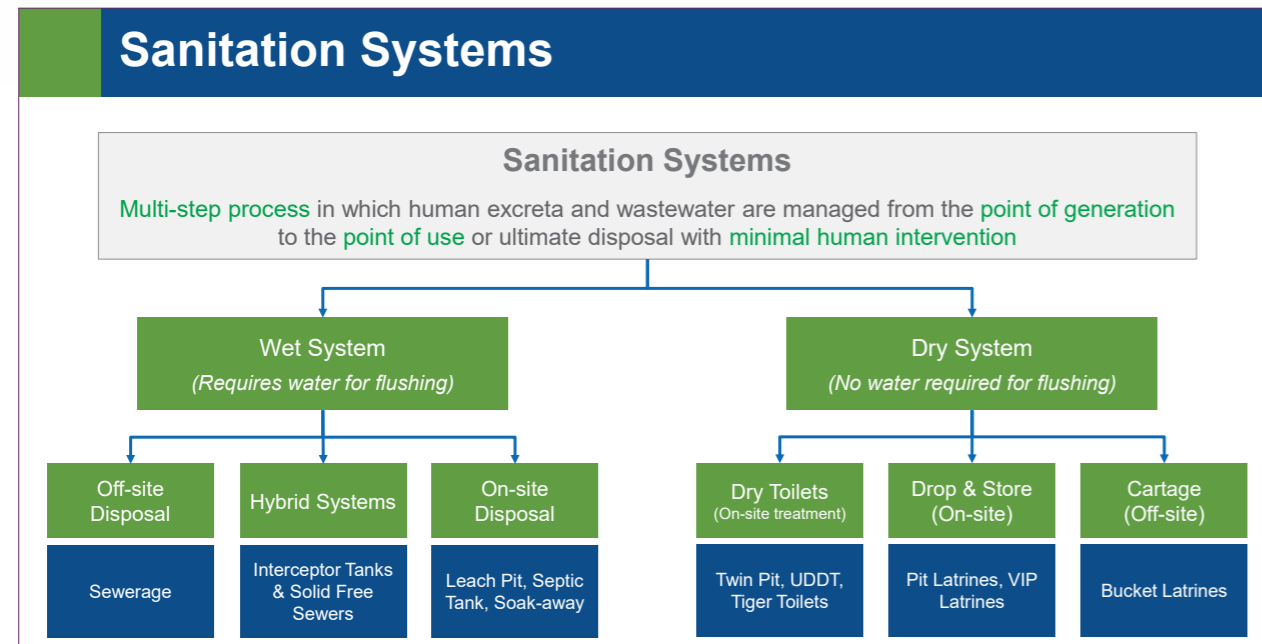

Sanitation Systems: It is a multi-step process in which human excreta and wastewater are managed from the point of generation to the point of use or ultimate disposal with minimal human intervention. It has two different types of system i.e. wet system and dry system. Wet system which requires water for flushing and dry system which doesn't require water for flushing.

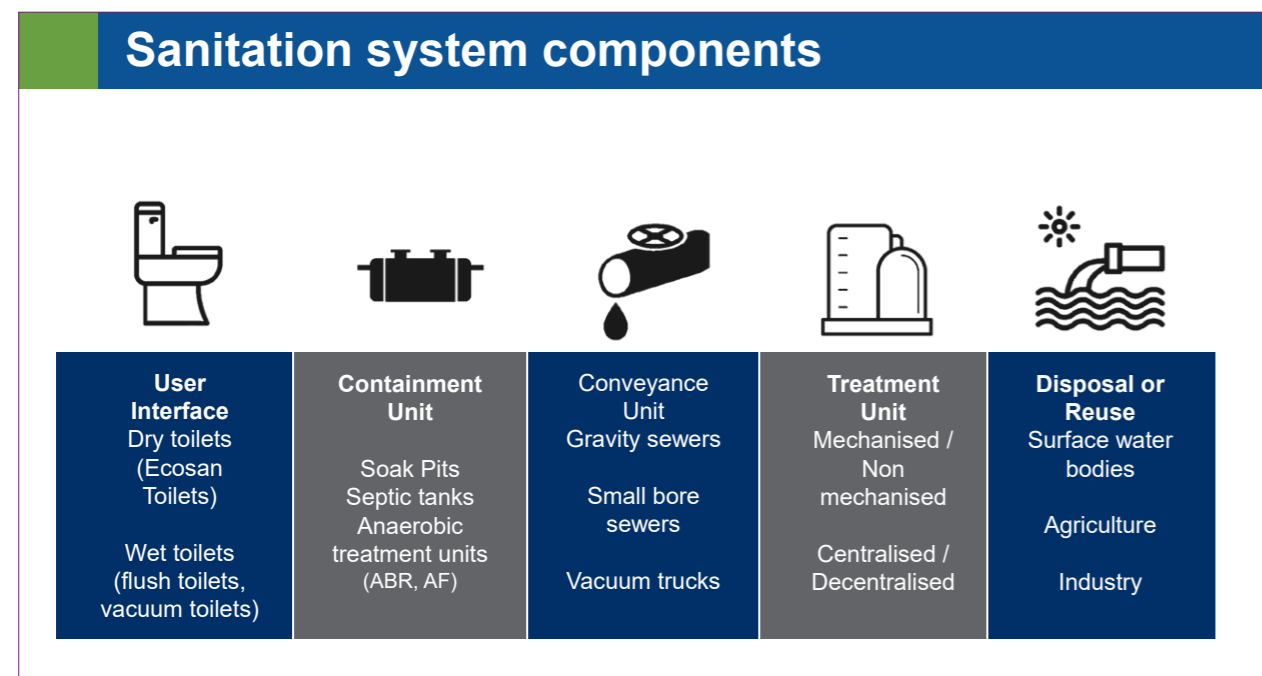

A sanitation system consists of five different components as shown in the slide- User Interface, Containment Unit, Conveyance Unit, Treatment Unit and Disposal or Reuse. A sanitation system can be formed using three or more components. The options available under each component is

listed in the boxes on the slide. We will be looking into different sanitation systems which will make the picture clearer as to how each component connects with other.

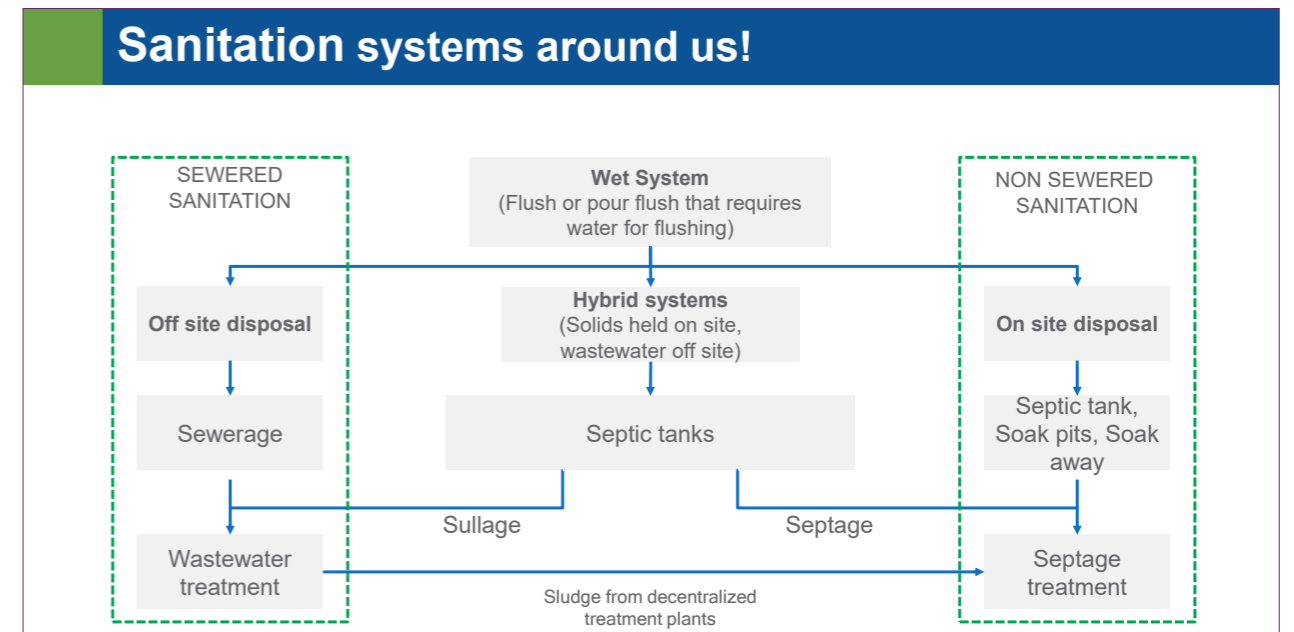

In the urban centres of the developing countries, due to availability of the water, use of flush toilets and the myth that wet systems are the easiest to operate and maintain, water borne systems are used. Water is used to transport the waste from one point to another. These systems are called wet systems. The wet systems can be classified into two types depending on where the treatment of waste is done. In case of "Off Site" disposal, the liquid and solids are carried away from the point of generation using sewerage network. The sewerage network brings the waste from all the households to one point where a wastewater treatment plant is set up. This type of system is called as sewerage sanitation.

In the case of "On Site" disposal, the solids are stored in the containment unit and the liquid effluent is disposed off into the ground using soak pits or soak away. After a duration of a few years, the contained solids are emptied and transported for further treatment. Since this conveyance of solids is done by mechanised equipment such as vacuum trucks, this type of sanitation system is called as non sewerage sanitation.

However, in India, we have developed a hybrid system where in the solids are contained in the septic tank at the household level and the sullage is disposed off into the drains outside the houses. The network of drains thus collects the sullage from all the households and by gravity brings it to the surface water body such as rivers, lakes and ponds. The septage from the septic tank is emptied after few years and transported by vacuum trucks for either treatment or direct disposal. Since a network of drains is involved for conveyance of the sullage, these systems cannot be classified as completely sewerage or non sewerage sanitation system.

## Pour Flush Pit System without Sludge Production

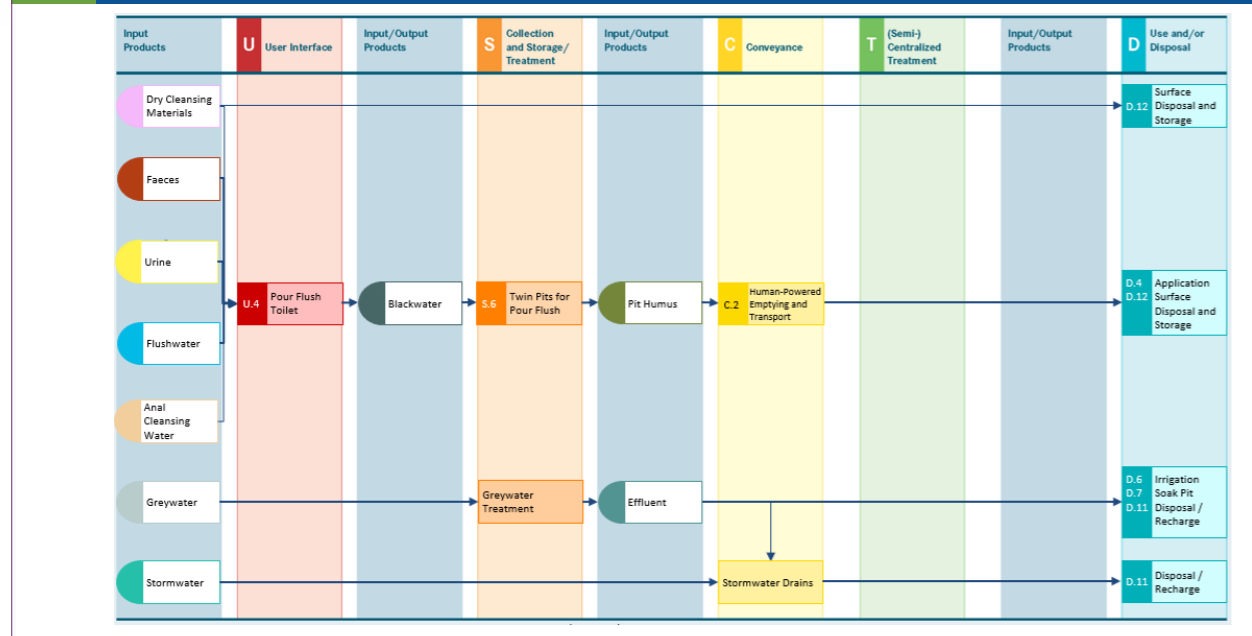

A flush toilet linked to twin pit (soak pits) is the best example of non sewered sanitation. In this case, the solids as well as liquids are catered to on site at the households' level. If properly designed units are installed, there is no requirement of an emptying and conveyance unit for managing the solids or liquid.

## Blackwater Treatment System with Infiltration

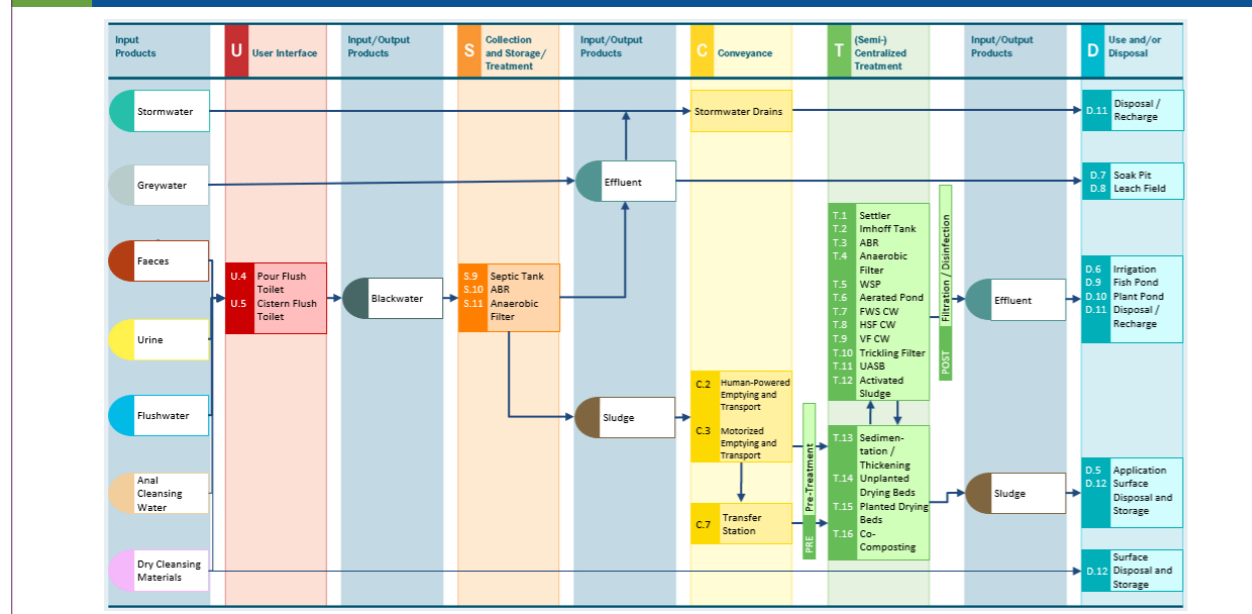

The slide shows another kind of non sewered sanitation system. In this case the blackwater is conveyed to a containment unit and the solids settle down and the liquid effluent is sent to disposal unit such as a soak field or leach field. The solids from the containment unit are emptied

and conveyed for further treatment to a (Semi) centralised treatment plant. Post treatment the solids and the liquid are disposed or reused.

## Blackwater Transport to Centralized System

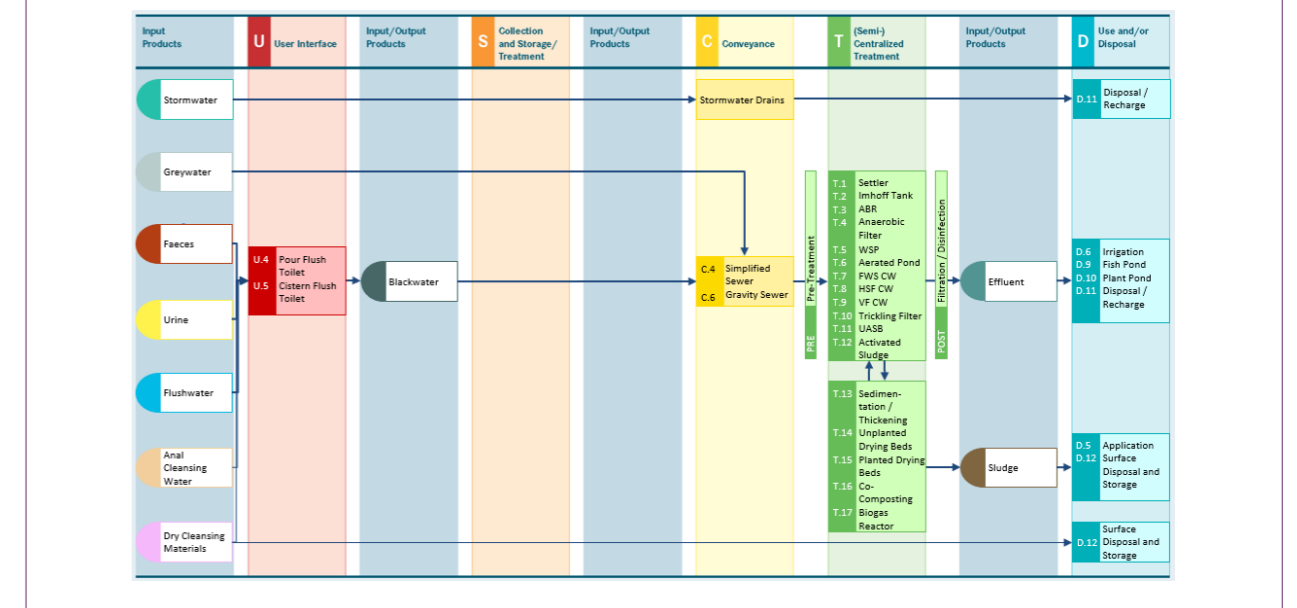

This slide showcases, completely sewerred sanitation system. Here the wastewater that is the mixture of black and grey water is conveyed for treatment using gravity sewer system. The wastewater thus collected is treated and disposed/ reused.

## Blackwater Treatment System with Effluent Transport

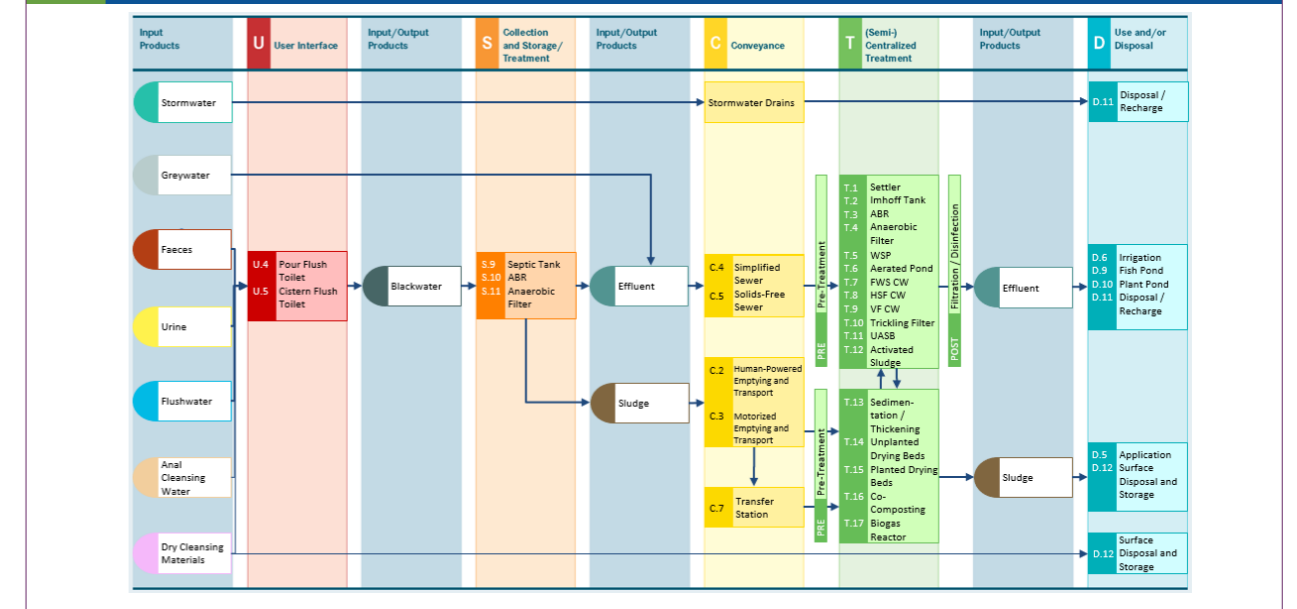

This slide represents a kind of hybrid system where in the liquid effluent from the containment unit is also collected and conveyed for treatment at a (semi) centralised treatment plant.

#### 4. What is Faecal Sludge & Septage?

### What is faecal sludge & septage?

- All liquid and semi-liquid contents of pits and vaults accumulating in on-site sanitation installations.
- High TSS and TDS than wastewater.
- Faecal sludge- fresh and yellowish, higher BOD, needs higher degree of treatment.
- Septage- well digested and blackish, lower BOD, needs lesser degree of treatment.

Depending on the type of the containment system and its design and holding period, the content of the pits (human excreta) undergoes digestion. The containment unit such as pits or under designed septic tank results into faecal sludge, whereas the units such as septic tanks is sludge holding capacity of 2-3 years or anaerobic treatment system such as digester produce septage. The content of septic tank has high TSS and TDS than wastewater. Faecal Sludge as mentioned earlier is fresh yellowish, higher BOD, non-settleable solids. Hence, it needs a higher degree of treatment. Septage on the other hand, is well digested black in colour, higher content of settleable solids and requires lesser degree of treatment.

### Faecal sludge and Septage



The slide shows picture of faecal sludge and septage. It is visibly easier to notice that the picture on the left is that of faecal sludge and the picture on the right depicts septage.

#### 5. Sanitation Value Chain

### Sanitation Service Chain (non sewer/hybrid)

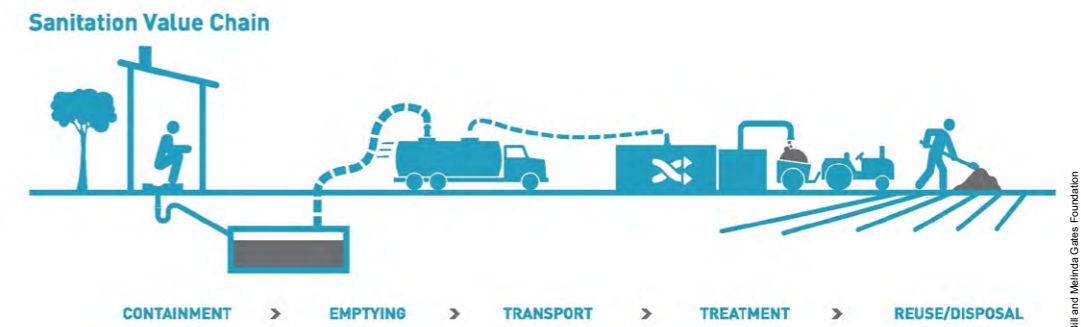

To manage the faecal sludge and septage, the sanitation system needs to be equipped for emptying and conveyance along with the treatment and reuse/disposal. Hence, there is a requirement of sanitation service chain. The service of emptying of septic tank to the households is given by the ULB or private operator. The mismanagement of service chain leads to greater negative impact on the environment and water resources.

#### 6 Needs & Challenges in Sanitation System

### Need of FSSM

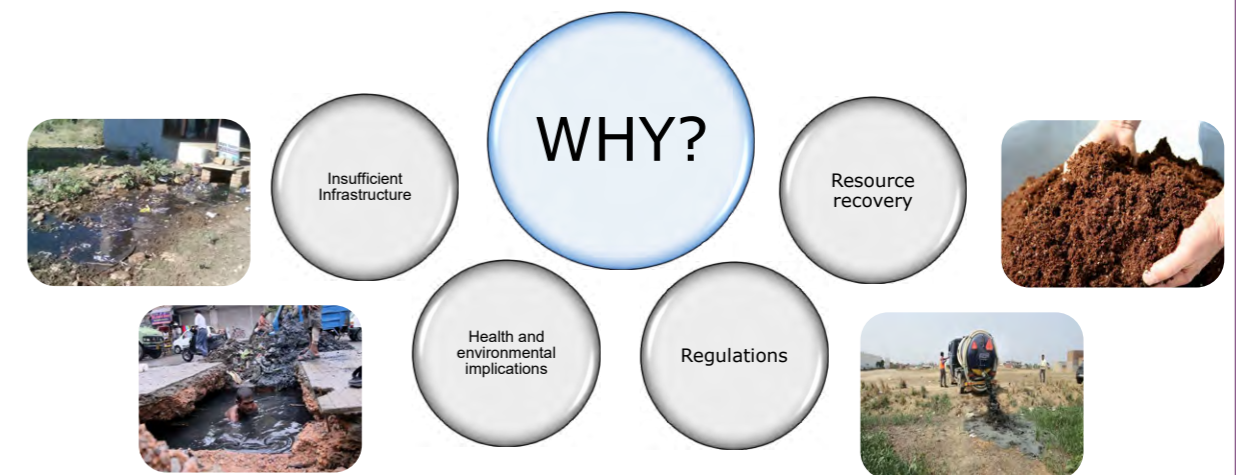

**Insufficient infrastructure:** The cities do not have adequate, properly designed infrastructure for managing the wastewater generated at city level. The coverage of the gravity sewer network and capacity to treat wastewater is limited. Hence, there is a need of acknowledging the need of FSSM. Through FSSM, the septage from the septic tank can also be well managed to reduce the pollution load on water resources.

**Health and environmental implications:** Water resources are usually shared by the cities. However, most of the cities having inadequate capacity to manage liquid waste, dispose it into the surface water bodies. The same surface water bodies are used as a source of raw water by

the cities in the downstream. Poorly designed gravity sewer system, also needs special attention. To clean the deposits (silt, grit and solid waste) from the sewer network, sewage workers are employed. Most of the times, no suitable PPE is provided to these workers during the work.

**Regulations:** The regulations demand the ULBs to provide desludging services to the households having septic tanks. The faecal sludge and septage further needs to be treated before putting it for reuse/disposal.

**Resource recovery:** Faecal sludge and septage if treated appropriately can provide ample amount of nutrients. It can also be used as a soil conditioner for improving the fertility and water retention properties of the soil. Some other treatment processes convert the biochar or fly ash. The biochar has decent calorific value and can be used in brick kilns small scale furnaces. It has good adsorption capacity and can be used to improve the soil conditions when mixed in appropriate quantities. Fly ash on the other hand is used for making bricks.

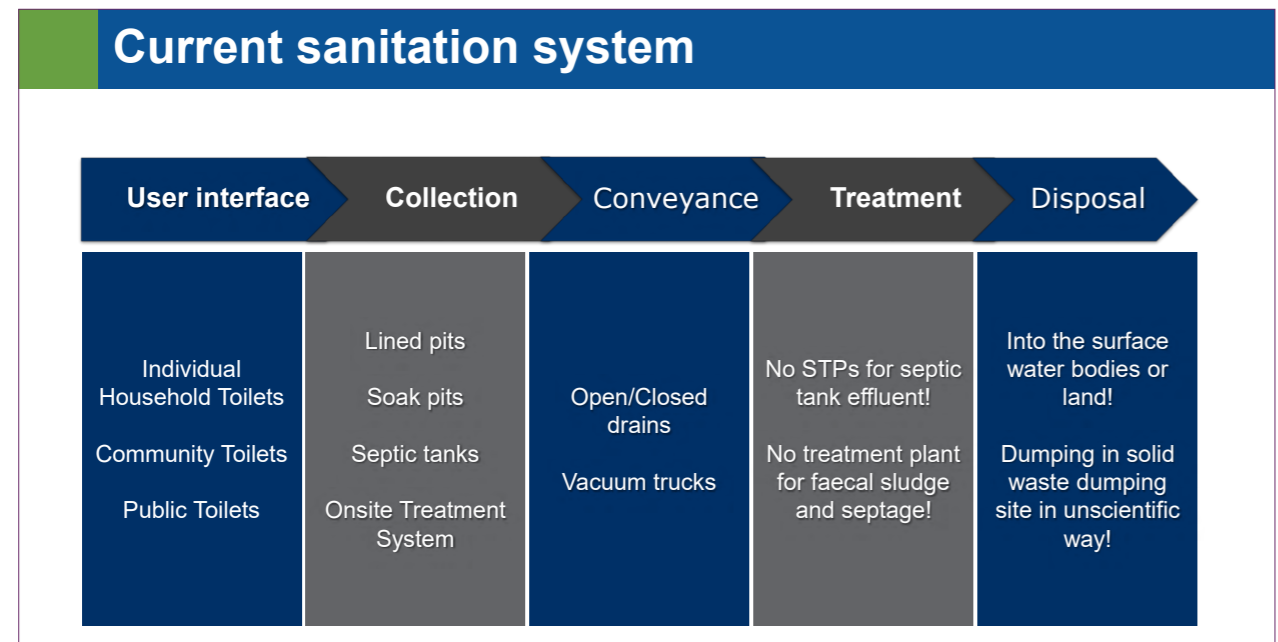

Since wet sanitation is practiced in India, most of the households, community and public toilets do have flush toilets (pour flush/ cistern flush). The black water from these toilets is sent to lined pits (termed as insanitary), twin pits (soak pits), septic tanks or any onsite treatment system. The effluent from the containment units such as septic tank is collected using network of open closed drains. Very few places, these containment systems are further linked to soak pit / drain field making it completely non-sewered system. The solids which settle in the tanks is digested and the sludge along with the scum and some water is emptied. The septage from the septic tank is emptied using desludging equipment such as vacuum trucks and conveyed to disposal point. Currently not many FSTPs or STPs are treating this septage and hence the septage is either disposed into the water bodies or dumped at the solid waste dumping sites.

### Challenges sanitation system

User interface

- Individual Household Toilets
- Community Toilets
- Public Toilets

- Space
- Affordability
- Water supply
- Electricity
- Poor O&M
- Quality of material and workmanship



The challenges with user interface is mostly with use and maintenance. Under SBM it was observed that space was one of the major factors for the households to not have toilets. Affordability of having toilet was not only linked to the physical infrastructure but also water. In drought prone areas, scarcity of the water deterred households from using the toilets. In cases of community and public toilet, absence of electricity and hence insufficient illumination and water for flushing discouraged its use. During SBM, toilets were built at a large scale rapidly to achieve the targets set by the GoI. However, on the ground the same was achieved with some compromise of quality of the material and workmanship.

Improper user interface discourages its uses and hence the open defecation still is practiced. Without use of the toilet, there is no generation of faecal sludge and septage for its management.

### Challenges sanitation system

Collection

- Lined pits
- Soak pits
- Septic tanks
- Onsite Treatment System

- Space
- Affordability
- Location
- No standard design
- Poor O&M



CEPT, Ahmedabad

## Challenges sanitation system

### Conveyance

- No monitoring of informal sector
- Unsafe handling
- Irregular desludging
- Inadequate equipment and machineries



Open/Closed drains  
Vacuum trucks



In case of containment systems, space and affordability is the major challenge. Lot of houses did not have for standard twin pits or septic tanks. Since containment units were not focussed on during promotion under SBM, households looked at it as an extra expenditure. Hence most of the places, the containment systems were not build properly following the standard design. These in turn resulted in operational difficulties. The maintenance of such units became costly and insufficient. In most instances, the septic tank is located at the backside of the house, limiting access to it. In such cases emptying of the septic tank becomes a challenge as most of the vacuum trucks have the service limitation of 100 ft.

## Challenges sanitation system

### Treatment

No STPs for septic tank effluent!

No treatment plant for faecal sludge and septage!

Indiscriminate disposal in

- Surface water bodies
- Land
- Drains
- Dump site



The main challenges faced by ULBs in the emptying and conveyance part is lack of equipment for providing desludging services, monitoring and irregular desludging frequencies. Due to insufficient equipment, in most cases there is a delay of one day to provide the desludging service. Apart from the ULB, in most cities there is a fleet of private operated vacuum trucks to also provide the desludging services. In absence of the proper regulations, the trucks are emptied in open drains or water bodies. Hence, a strict monitoring is required. Since there is no awareness regarding frequency of desludging of septic tanks and its importance, the demand for desludging is usually seen during emergencies such as back flow/ over flow from the septic tanks and strong stench from the toilets. Septic tank needs to be desludged at a certain frequency for maintaining its efficiency of sedimentation.

## Challenges sanitation system

### Disposal

Into the surface water bodies or land!

Dumping in solid waste dumping site in unscientific way!

- BOD and other parameters of FS and septage are higher than wastewater.
- Once the solids are stabilised and separated from FS/septage, liquid effluent should be treated.
- CPCB has revised new standards for discharge of treated effluents.

Most of the cities are not having FSTPs or STPs for treating the wastewater or septage. Hence, in absence of proper disposal point, the septage is indiscriminately disposed off in to the surface water bodies or on to the land. This leads to more pollution and health hazard when compared to open defecation.

There are no regulations at the ULB level for proper disposal of FSSM in absence of treatment facility. Since the solid content of faecal sludge and septage significantly high when compared to wastewater, indiscriminate disposal of it possesses a bigger health hazard. As a precautionary measure, the ULBs should at least practice scientific land disposal to reduce the spread of the pollution.

## Challenges in FSSM

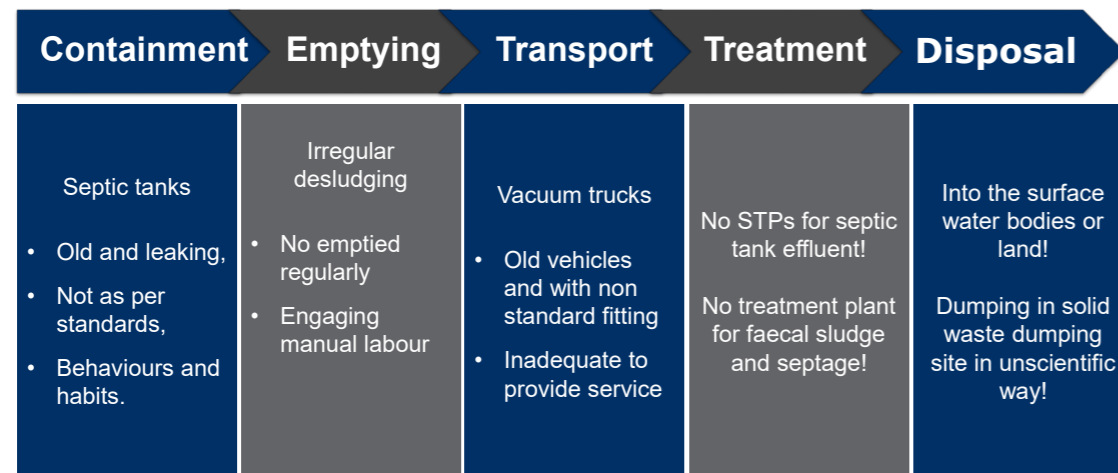

This slide shows all the challenges in the operationalizing FSSM. However, it should be noted that most of these challenges can be overcome by having regulations and policies for FSSM. With minimum investment, these challenges can be overcome to increase the sanitation coverage. FSSM is the solution to manage the liquid waste properly and improving the sanitation coverage until the sewerage sanitation system is developed.

## Summary

- Development of sanitation infrastructure in a fast urbanizing country like India is quite challenging.
- Govt have released appropriate policies and acts for operationalising FSSM.
- Understanding and choosing appropriate sanitation system is very important.
- Challenges in FSSM are relatively easier to tackle as compared to the one in sewerage sanitation.

Session

02

# Quantification of Faecal Sludge & Septage

## Learning objectives

In this session we are trying to understand the methods to quantify faecal sludge and septage at city scale.

You will also know the kind of data and its reliability to quantify the faecal sludge and septage.

# Contents

## Quantification of faecal sludge and septage

- Why quantification is necessary?
- Sludge production method
- Sludge collection method
  - Seasonal variation
  - Peaking factor

### 1. Why quantification is necessary?

## Why quantification is necessary?

### • Type of desludging envisaged?

- Demand desludging
- Scheduled desludging

### • Scale of collection and transport network

### • Identifying discharge sites (co treatment)

### • Proper sizing of infrastructure

- Faecal sludge and septage treatment plant
- End-use and disposal mechanism



Quantification of the faecal sludge and septage and the data needed to arrive at the number largely depends on the type of desludging envisaged in the city. The quantification is real challenge in case of demand desludging where in depth understanding is required about the behaviour of the households towards emptying of their septic tanks. In case of schedule desludging, the data can be collected from the ULBs and couple it with sample surveys. However, to operationalize scheduled desludging appropriate regulations need to be passed at the ULB level.

Quantification is necessary for gauging the scale of collection and transport network, identifying the number and types of discharge sites. It is also needed to arrive at required design capacity of the FSTP and adopt an appropriate financial model for sustaining the FSSM services.

## Methods of quantification

<h3 style="color: #0056b3; margin: 0;">Sludge production method</h3> <ul style="list-style-type: none"> <li>Estimates total sludge production</li> <li>Starts with primary data collection – household survey</li> <li>Carried out in case of scheduled desludging</li> </ul>	<h3 style="color: #0056b3; margin: 0;">Sludge collection method</h3> <ul style="list-style-type: none"> <li>Estimates sludge loading rate at the treatment plant</li> <li>Start with collection and transport companies (legal &amp; illegal)</li> <li>Carried out in case of demand desludging</li> </ul>
---	--

**Many assumptions need to be made in both the methods due to lack of available information!**

There are two methods of quantification- production method and collection method. The sludge production method is based on the standard septage generation rate. This method needs to be followed, in case where scheduled desludging needs to be practiced. The collection method is based on the quantity of the septage collected from the households by the existing vacuum trucks and its operators. This method needs to be followed in case demand desludging needs to be followed.

However, one needs to understand that both the methods individually are not completely reliable and requires assumption. Hence the methods need to be tweaked depending on the data already available with the ULB and ground conditions.

## 2. Sludge Production Method

## Sludge production method

<ul style="list-style-type: none"> <li>Number of users</li> <li>Location</li> <li>Types and number of various onsite systems</li> <li>Population of different socio-economic levels</li> </ul>	<p>IS: 2470 Code for practice for Installation of Septic Tanks (Part 1: Design Criteria and construction)- 1985</p> <p>Volume of digested sludge</p> <p>0.00021 m<sup>3</sup>/cap/d ~ 76.65 L/cap/annum</p> <p>US EPA: Technology Transfer Handbook on Septage Treatment and Disposal</p> <p>Average per capita septage generation</p> <p>230 L/cap/d</p>
--	---

The sludge production method, is based on the empirical number called volume of digested sludge in a septic tank. As per the IS 2470 which gives the practice of installation of septic tank the volume of digested sludge can be calculated as 0.00021 cum per person per day. In the US, the septage generation rate varies from 190 L/cap/d to 265 L/cap/d; whereas the same in Germany is between 110 to 4380 L/cap/d. In the US EPA manual, the average per capita septage generation is recommended as 230 L per capita per day. However, this number needs to be used carefully as it differs depending criteria linked to dietary habits of the person and usage of the toilet.

## Challenges faced!

- Faeces production vary significantly on dietary habits.
- Not just the quantity but quality of the faecal sludge also vary.
- Volume of urine excreted also change depending on liquid consumption, physical activity and climate.
- Scarcity of data: onsite sanitation systems built informally.
- Not all what is generated is collected!

The sludge production rate may vary depending on dietary habit. It's not just the quantity but also the quality which may change due to this. The scarcity of the data pertaining to onsite sanitation systems (containment units) built is quite prevalent in the ULBs. Since the desludging frequency of not set, not all the faecal sludge which is generated every year is collected annually.



### 3. Sludge Collection Method

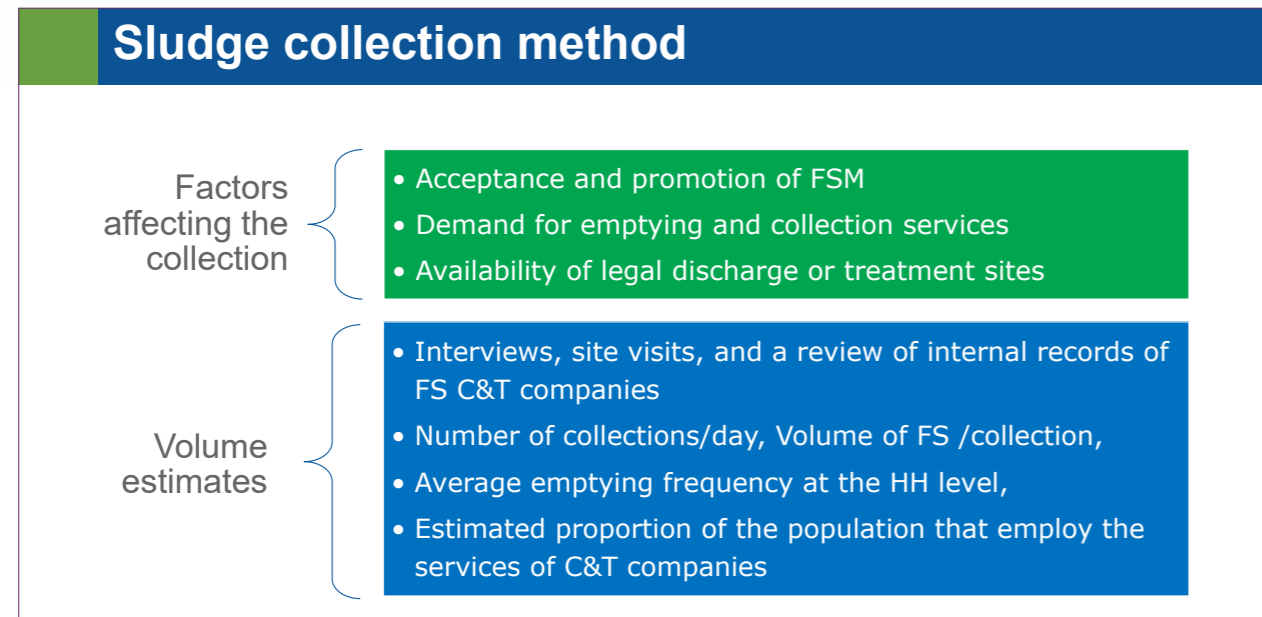

The sludge collection method relies on the inferences drawn from the structured interviews conducted with various stakeholders of FSSM. There are various factors affecting the collection and all are taken into considered during the data collection.

A structured interview consists of direct and indirect questions leading to data needed for assessing the quantity of faecal sludge and septage collected on a daily basis. Inferences need to be drawn from the responses received during the interviews.

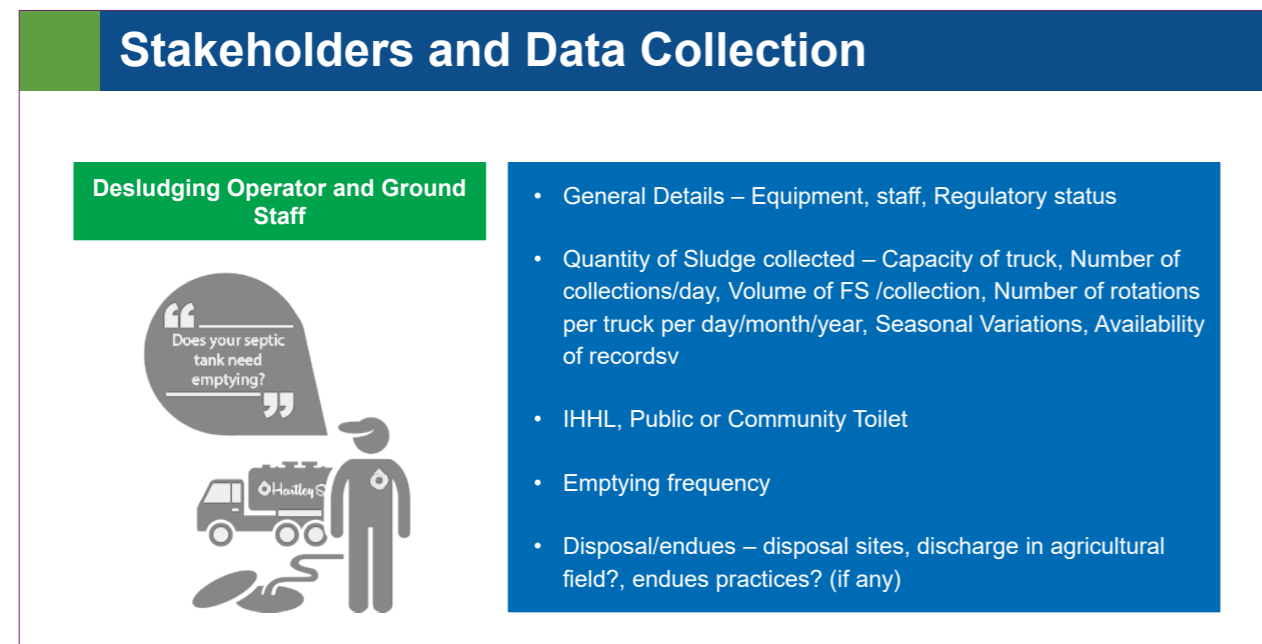

There are 3 key stakeholders i.e. desludging operator and his ground staff, ULB officials and Households with whom we have to carry out consultations and have to collect the data. It is very important to have structured interviews with them for appropriate quantification

### Desludging Operator and Ground Staff

- General Details – Equipment, staff, Regulatory status
- Quantity of Sludge collected – Capacity of truck, number of rotations per truck per day/month/year, Seasonal Variations, Availability of records
- IHHL, Public or Community Toilet
- Emptying frequency
- Disposal/endues – disposal sites, discharge in agricultural field? endues practices?

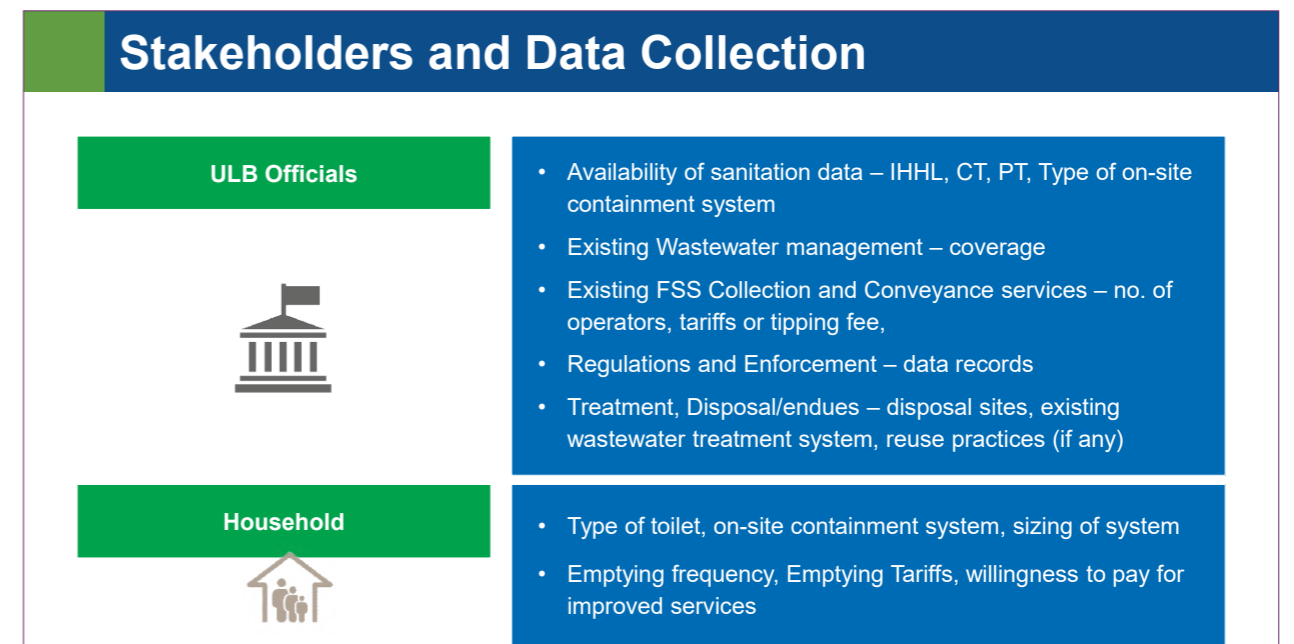

### ULB Officials

- Availability of sanitation data – IHHL, CT, PT, Type of on-site containment system
- Existing Wastewater management – coverage
- Existing FSS Collection and Conveyance services – no. of operators, tariffs or tipping fee
- Regulatory Framework – Municipal Bylaws or FSSM Policy
- Treatment, Disposal/endues – disposal sites, existing wastewater treatment system, reuse practices (if any)

### Household

- Type of toilet, on-site containment system, volume
- Emptying frequency, Emptying Tariffs, willingness to pay for improved services

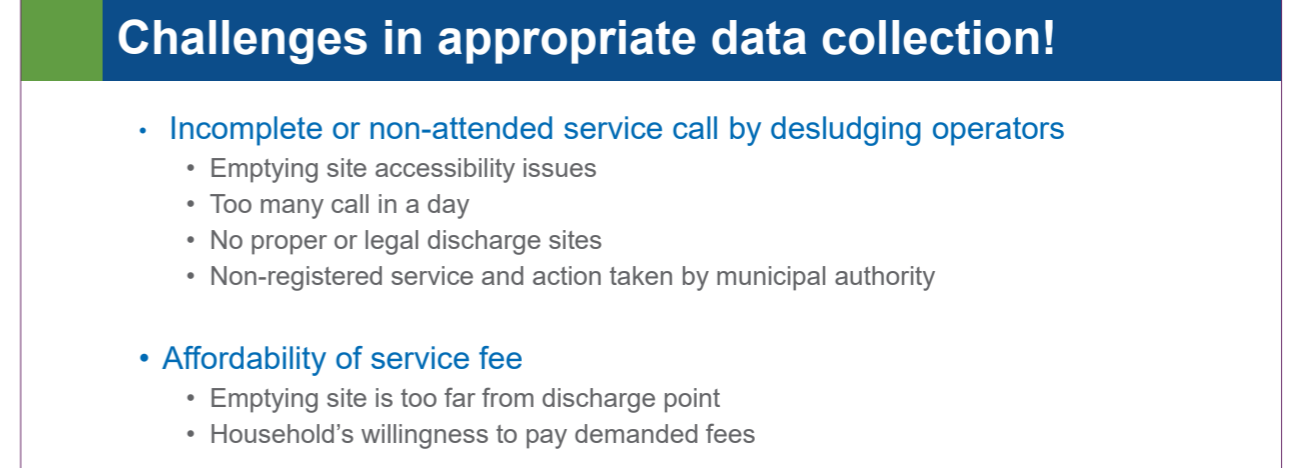

Sometime it happened that some data is missed or not informed by the stakeholders like desludging operators or ground staff or household because of illegal or improper approach.

For example, in case of desludging operators and in demand-based services sometime there will be few service calls which are incomplete or not attended. There are many reasons for this like they don't get proper access to the containment system for emptying or there are many calls in a day for specific period so they couldn't attend the all calls. In some cases, private operators are not registered with the ULBs and they are practicing illegal discharge of emptied FSS so sometime they refused to service call as they didn't get access to legal or proper discharge site or some legal action taken by municipal authority.

In another case like the affordability of service fee. For example, emptying site was too far from the discharge point so desludging operator is asking for extra service fees which is non affordable to the household. Even, as private services don't have specific fixed charges sometimes it's not feasible to household and unfortunately, they prefer illegal manual emptying service.

These kind of data points sometimes missed in the study which may effect on the final quantification of FSS and indirectly on the further planning and designing approach in FSSM

## Seasonal variations

- Desludging demand increases during high ground water tables, extended rainfall or snowmelt.
- Some desludging takes place all round the year (hotels, schools, restaurants, community sanitation blocks, public sanitation blocks)

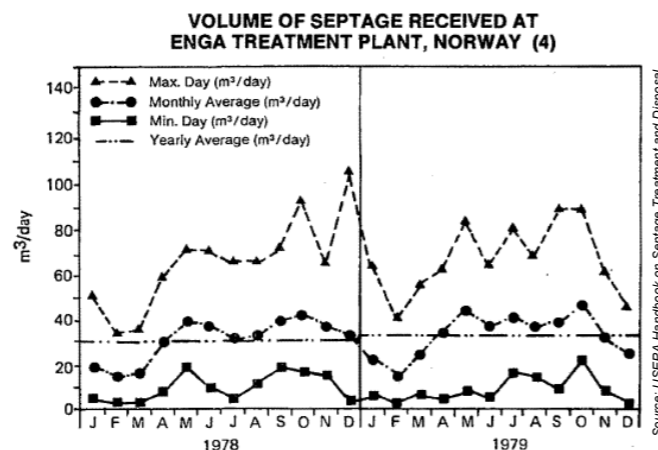

Seasonal variation needs to be taken into consideration during the structured interviews. The graph on the slide shows that the average monthly collection differs for the same plant. In case of demand desludging, the demand for septic tank emptying might increase or decrease depending upon certain factors such as – high intensity rainfall leading to overflow of septic tank, decrease in ambient temperature leading to reduction in digestion rate. However, there are still some properties such as restaurants and commercial offices, public sanitation facilities which regularly desludge the septic tanks throughout the year.

## Peaking factors

- Peaking factor is the ratio of the maximum to the average quantity received over a period of time.
- Peaking factor can range from 1.5 to 4.0 in some cases.
- Data needs to be collected and analysed to know the peaking factor.

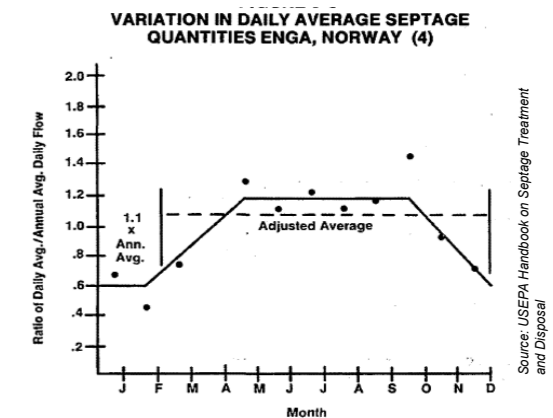

Peaking factor needs to be understood while estimating the quantity of septage. The peaking factor caters to the variations in the monthly collection of septage. The peaking factor can range from 1.5 times to 4 times the monthly average. This needs to be fixed based on the inferences drawn from the structured interviews.

## Challenges faced!

- Number of discharge location or demand for the septage.
- In case of discharge at STP, affordability of discharge fee.
- A large informal sector is working in the business of “septic tank cleaning”.
- Not all what is collected reaches the treatment plant.
- Identification of new legal discharge point might increase the frequency of the desludging.

The quantity of the septage collected also depends on the availability of discharge locations or demand of septage among farmers. If there are multiple discharge points available, then operators will not have to turn down the request of the septic tank desludging. The collection might also change depending upon the desludging fees. A large informal sector exists in emptying of septic tanks which goes unmonitored. Not all the collected septage reaches at the designated discharge point for treatment. In absence of proper monitoring, the FSTP might still receive less septage because of indiscriminate disposal.

## Summary

- Planning of Faecal Sludge and Septage Management depends on quantification of Faecal Sludge and Septage
- Sludge production method – empirical method
- Sludge collection method– reliable and more robust
- Seasonal variation can be quite prominent depending on the local conditions
- Peaking factor should be considered while quantification

Session

**03**

# **Characterization of Faecal Sludge & Septage**

---

## Learning objectives

In this session we will understand;

- How the faecal sludge and septage differ from sewage and sewage sludge.
- To understand the characterisation ratios, which are required to select appropriate treatment processes.
- To understand the operational factors which might change the characteristic of the faecal sludge and septage.

## Contents

### Faecal Sludge and Septage Characterization

- Parameters
- Comparison of different sludges based on sources
- Characterisation ratios
- Operational factors

## 1. Parameters

**Parameters**

- Solid Concentration (TS, TVS, TSS, VSS)
- Chemical Oxygen Demand (COD)
- Biochemical Oxygen Demand (BOD)
- Nutrients (TKN, NH<sub>3</sub>-N, Total P)
- Pathogens
- Metals



The parameters which are used to characterise septage are similar to the one used in the case of wastewater. The parameters are listed above in the slide. It is very important that all the parameters and their interdependence is understood well. In case of the septage coming from the septic tank installed at the household, one need not worry about metals. However, in the case where small medium scale industries are run at the household level, the septage might also contain heavy metals.

Ex. In unorganized housing units, usually small scale industries such as dyeing of textile or metal fabrication units are run. In this case, if the process water is disposed off into the septic tank then the septage will contain the heavy metals from the dyes and fabrication processes.

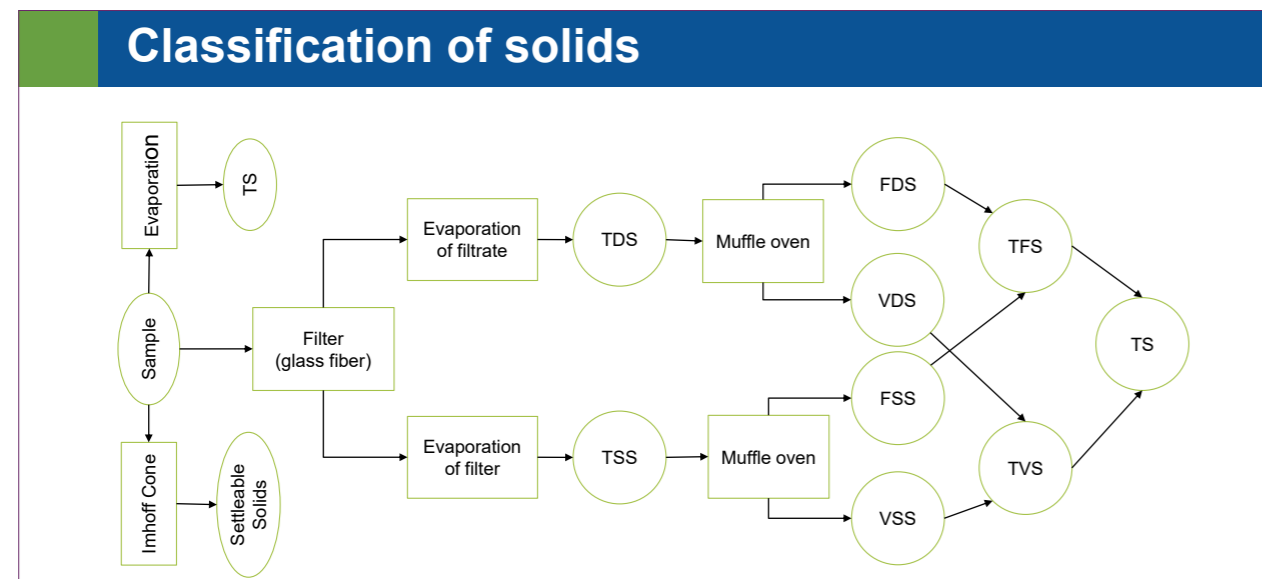

The solids in the wastewater, faecal sludge and septage can be classified as shown in the slide above. The solids are either dissolved or suspended. The suspended solids are further classified in easily settleable solids. The suspended and dissolved can be further classified into volatile and fixed solids. Fixed solids are those which are retained in the sample after exposing it to higher

temperatures. The content of volatile solids determines the degree of stabilisation of the solids. However, the literature says that the TSS in septage is quite high and most of which are easily settleable. Hence a simple solid liquid separation helps to reduce the VSS and COD of the liquid portion of the septage.

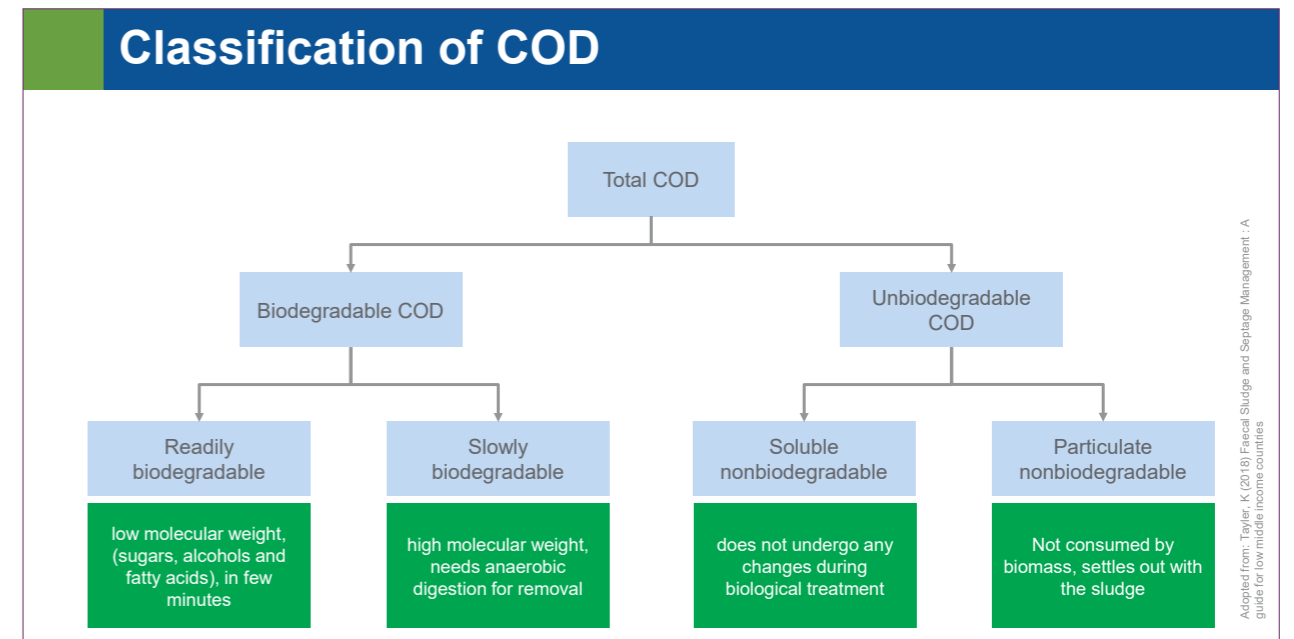

The slide shows classification of COD in liquid waste such as faecal sludge or septage. The total COD can be classified into biodegradable and non-biodegradable COD. The Biodegradable COD can be further classified into readily biodegradable and slowly biodegradable. The slowly biodegradable COD content of faecal sludge is much higher than septage. Hence in order to stabilise the faecal sludge, anaerobic digestion with more retention time is required.

The non-biodegradable COD can be further classified into soluble and particulate non-biodegradable COD. It is important to note that septage has significantly higher amount of particulate non-biodegradable COD. This means septage does not need much stabilisation and COD reduction in septage can be achieved by simply removing the suspended solids from the liquid fraction.

## 2. Comparison of different sludge's based on sources

**Comparison of septage and sewage**

Parameter	Septage	Sewage	Ratio of septage to sewage
TS	40,000	720	55:1
TVS	25,000	365	68:1
TSS	15,000	220	68:1
VSS	10,000	165	61:1
BOD <sub>5</sub>	7,000	220	32:1
COD	15,000	500	30:1
TKN	700	40	17:1
NH <sub>3</sub> -N	150	25	6:1
Total P	250	8	31:1
Grease	8,000	100	80:1

Source: USEPA Handbook on Septage Treatment and Disposal

This slide shows the strength of septage and sewage and provides us with a ratio to understand how concentrated septage can be when compared to sewage. The total solid content is significantly high when compared to sewage. This is the result of digestion of the accumulated sludge over a period of time. It can be seen that volatile solids and suspended solids both are significantly high as compared to sewage. This results in high COD too. Since the accumulated faecal sludge is digested over a period of time, the result of the digestion is inorganic particles. Nutrient content is also high in septage and so it's the grease. The grease content is high because fats, oil and grease has been accumulating over a period of time in the septic tank and now has been mixed and emptied with limited quantity of water (equivalent to volume of septic tank).

Parameter	FS source		WWTP sludge	Reference
	Public toilet	Septic tank		
pH	1.5-12.6			USEPA (1994)
	6.55-9.34			Kengne <i>et al.</i> (2011)
Total Solids, TS (mg/L)	52,500	12,000-35,000	-	Koné and Strauss (2004)
	30,000	22,000	-	NWSC (2008)
		34,106		USEPA (1994)
	≥3.5%	<3%	<1%	Heinss <i>et al.</i> (1998)
Total Volatile Solids, TVS (as % of TS)	68	50-73	-	Koné and Strauss (2004)
	65	45	-	NWSC (2008)
COD (mg/L)	49,000	1,200-7,800	-	Koné and Strauss (2004)
	30,000	10,000	7-608	NWSC (2008)
	20,000-50,000	<10,000	500-2,500	Heinss <i>et al.</i> (1998)
BOD (mg/L)	7,600	840-2,600	-	Koné and Strauss (2004)
	-	-	20-229	NWSC (2008)

This slide shows the characteristic of three different types of sludge depending upon its source- public toilet, septic tank (household) and STP. Thus in case of Indian cities, it needs to be understood that different types of sludge might arrive at the treatment facility. In India, due to the increasing number of decentralised wastewater treatment plants (aerobic as well as anaerobic) sewage sludge might also be received at the treatment facility. Ex. In case of Port Blair, every resort having more than 20 rooms are mandated to have a STP. Most of the resorts, in order to avoid the odour nuisance, store the sewage sludge in the storage tanks and call for the vacuum trucks to empty them frequently. Thus, in the case of Port Blair, all the three types of sludges are bound to come for treatment at the treatment facility. The degree of treatment required to treat these sludges is different.

### Characteristics of Faecal sludge from different sources and WWTP sludge

Total Nitrogen, TN (mg/L)	-	190-300	-	Koné and Strauss (2004)
			32-250	NWSC (2008)
Total Kjeldahl Nitrogen, TKN (mg/L)	3,400	1,000	-	Katukiza <i>et al.</i> (2012)
NH <sub>4</sub> -N (mg/L)	3,300	150-1,200	-	Koné and Strauss (2004)
	2,000	400	2-168	NWSC (2008)
	2,000-5,000	<1,000	30-70	Heinss <i>et al.</i> (1998)
Nitrates, NO <sub>3</sub> <sup>-</sup> (mg N/L)	-	0.2-21	-	Koottatep <i>et al.</i> (2005)
Total Phosphorus, TP (mg P/L)	450	150	9-63	NWSC (2008)
Faecal coliforms (cfu/100 mL)	1x10 <sup>5</sup>	1x10 <sup>5</sup>	6.3x10 <sup>4</sup> -6.6x10 <sup>5</sup>	NWSC (2008)
Helminth eggs (Numbers/L)	2,500	4,000-5,700	-	Heinss <i>et al.</i> (1994)
	20,000-60,000	4,000	300-2,000	Heinss <i>et al.</i> (1998)
		600-6,000		Ingallinella <i>et al.</i> (2002)
		16,000		Yen-Phi <i>et al.</i> (2010)

### Characterization based on COD

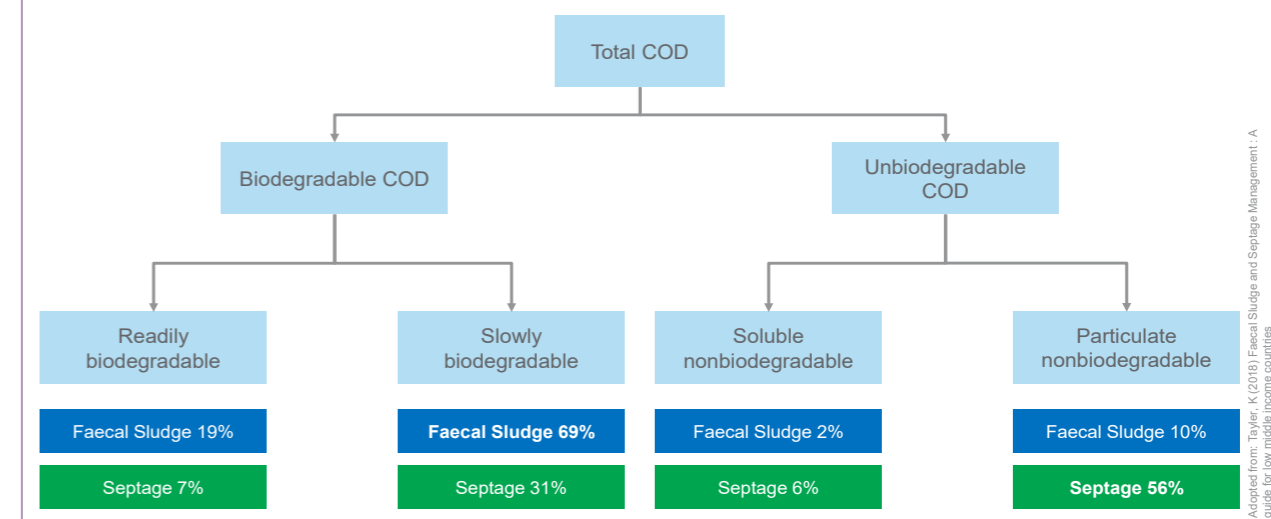

### 3. Characterization ratios

Characterisation ratios			
Ratio (gm/gm)	Public toilets	Septic tanks	Medium strength wastewater
VSS:TSS	0.65-0.68	0.50-0.73	0.60-0.80
COD:BOD <sub>5</sub>	5.0	1.43-3.0	2.0-2.5
COD:TKN	0.10	1.2-7.8	8-12
BOD <sub>5</sub> :TKN	2.2	0.84-2.6	4-6
COD:TP	109	8.0-52	35-45
BOD <sub>5</sub> :TP	17	5.6-17.3	15-20

Characterisation ratios help us to understand the degree of treatment required for the waste. These ratios help us to identify appropriate treatment processes. The percent of volatile solids to suspended solids tell us about stabilisation of the sludge. Higher the quantity of the VSS means the sludge needs stabilisation. If stabilisation is done using anaerobic digestion, then there is production of biogas which can be used for energy production. The COD: BOD ratios tells us; how much fraction of the organic solids are easily degradable. The higher ratio indicates higher presence of difficult to digest solids. Hence, such kind of sludge can be sent for anaerobic digestion to obtain biogas. The organic content to nitrogen ratios also indicate that the organic concentrations are not sufficient for nitrogen removal by denitrification.

### 4. Operational Factors

## Operational Factors

**Toilet Usage**

- Washers & wipers
- Inclusion – exclusion of grey water
- Use of additives for reducing filling rates of onsite sanitation system.



**Storage Duration**

- Type of technology
- Toilet usage

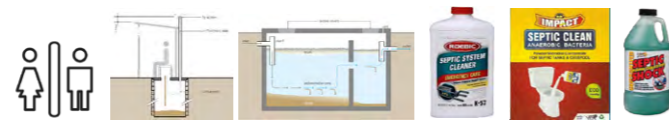

Operational factors such as toilet usage and cleansing material also affects the sludge production rate. Grey water inclusion may increase or decrease the sludge production. The grey water might include more chemicals which change the pH of the water, this affects the digestion rate. The

storage duration also determines the volume of sludge in the septic tank. Higher the storage duration, the volume decreases.

Some households also use additives such as microbial cultures which accelerates the digestion rate. Thus, it extends the septic tank emptying frequency.

## Operational Factors

**Climate**



- Temperature and moisture dependent
- High temperature – high biological degradation rate



**Infiltration and Exfiltration**



- Quality of construction
- Exfiltration – thicker sludge and infiltration – diluted sludge

Infiltration and exfiltration of water from the containment system also affects the quality of the sludge. In monsoon season, during high rainfall the infiltration of the water into the septic tank dilute sludge. The SS content will be less and so will be the BOD and COD of the water.

The cities having low average annual temperature will experience high sludge production rate. The rate of digestion of the sludge reduces at lower temperature and hence septic tank fills up at a faster rate.

## Operational Factors

**Equipment used**

- Human powered emptying – Thicker sludge,
- Motorised emptying – Dilute sludge

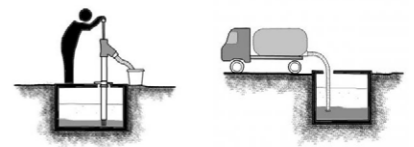

**Vacuum pump**

- High power – does not need water for dilution
- Low power – needs water for reducing viscosity

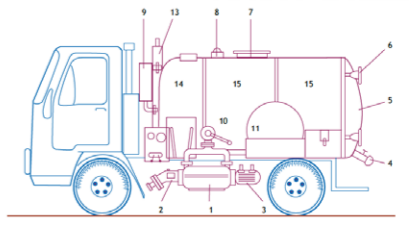

The collection method also determines the consistency of the septage from the septic tank. In cases where the septic tank is not desludged for prolonged time, water is used to break the sludge and help the vacuum to work efficiently. In that case the water content in the septage will be higher.

## Summary

- Parameters considered for characterisation of FSS is same as that of wastewater
- FSS although similar in characteristics, is much more stronger than sewage
- Characteristics of FSS change depending upon the source
- Characterisation ratio is considered while choosing the right treatment processes
- Operational factors affect the characteristics of FSS

Session

04

# Containment Systems: Sources of Faecal Sludge & Septage



## Learning objectives

The objective of the session is to understand different types of containment units and their design criteria.

To understand different kinds of processes taking place in the containment units on the influent and treat it to some extent.

## Contents

- Containment unit
- Types of containment units
  - Twin pit
  - Septic tank
  - Anaerobic baffled reactor
  - Anaerobic up flow filter
- Actual containment units

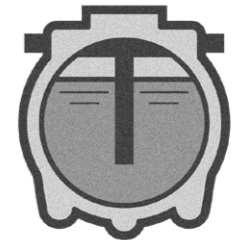

### 1. Containment Units

The containment units are connected to the user interface and are ideally designed for black water. The grey water however, is connected to the containment unit in some cases. Depending upon the type of unit, physical processes such as filtration or sedimentation may take place. The solids thus contained in the unit undergo anaerobic digestion depending upon the storage time, temperature and pH. This results in reduction of TSS, BOD and COD.

## Containment units

- Connected to user interface (toilet)
- Intercepts the black water (grey water in some cases)
- Physical mechanism- physical filtration or sedimentation
- Biological mechanism- anaerobic digestion
- Reduction in TSS, BOD and COD.

The objective of a containment system is to arrest the solids from the black water. Further these solids need to be digested so that stabilisation of the solids and reduction in volume happen. After separation of the solids, the containment unit needs to discharge the liquid effluent. The location of the containment units should be such that it is easily accessible for emptying whenever needed.

## Objective

- Collect and safely store the easily settleable solids in the black water
- Digest the settled solids to reduce the volume and BOD
- Discharge the liquid effluent to the soak away unit or to conveyance system- drains
- Easily accessible for emptying purpose

## 2. Types of Containment Units

There are different types of containment units possible and in use in India. Few of the most common ones are listed above in the slide.

## Types of containment systems

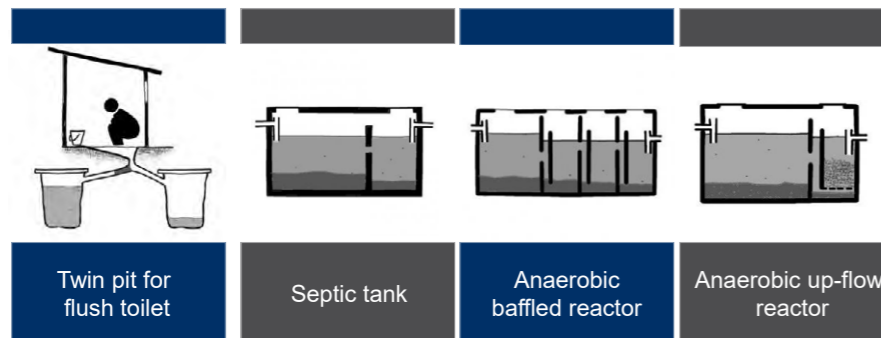

This technology consists of two alternating pits connected to a pour flush toilet. The blackwater (and in some cases greywater) is collected in the pits and allowed to slowly infiltrate into the surrounding soil. Over time, the solids are sufficiently dewatered and can be manually removed with a shovel and reused on-site, much like compost, to improve soil fertility and fertilise crops. Although most pathogens are filtered during soil infiltration or die-off with time and distance, there remains a risk of groundwater pollution, particularly in densely populated areas or in areas with a high groundwater table.

## Twin pit for pour flush toilet

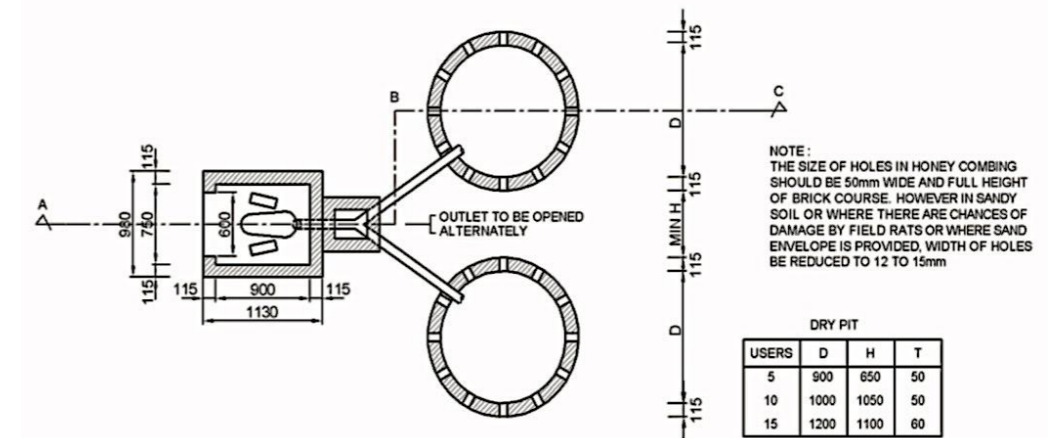

The above slides show the cross section of the twin pits and specification of the material and construction.

## Twin pit for pour flush toilet

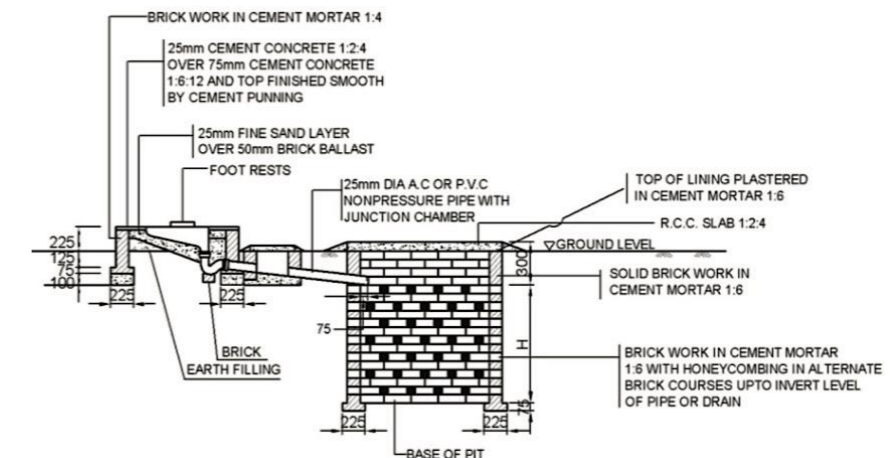

A septic tank is a watertight chamber made of brick work, concrete, fibreglass, PVC or plastic, through which blackwater from cistern or pour-flush toilets and greywater through a pipe from inside a building or an outside toilet flows for primary treatment. Settling and anaerobic processes reduce solids and organics, but the treatment is only moderate. Effluent is infiltrated into the ground or transported via a sewer to a (semi-)centralised treatment plant. Accumulating faecal sludge needs to be emptied from the chamber regularly and correctly disposed of.

## Septic tank

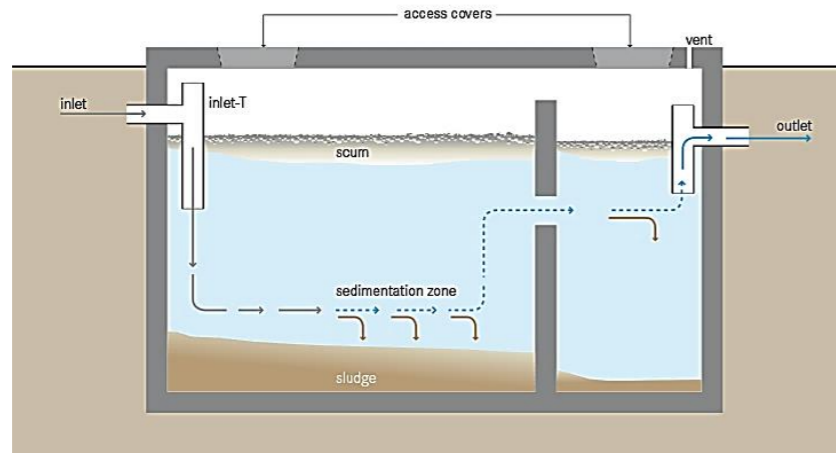

The design criteria for designing a septic tank are given above in the slide. The hydraulic retention time of at least 24 hours helps to sediment most of the easily settleable solids from the black water. The minimum liquid depth of 1000 mm ensures proper sedimentation. The length to breadth ratio of more than 2 ensures that solids settle in the time taken by water to reach from inlet to the outlet. Some volume of the septic tank needs to be reserved for scum that is the oil grease fats. When 2/3 of the tank is full with accumulated sludge and scum, it needs to be desludged. While desludging it needs to be made sure that certain amount of sludge should be left behind. This acts as inoculant for the incoming solids.

## Design criteria

- Hydraulic retention time should be at least 24 hr
- Liquid depth at least 1000 mm + 300 mm (freeboard)
- Maximum depth 1800 mm + 450 mm (freeboard)
- Length to Breadth ratio: 2-3:1
- Scum and accumulated sludge to occupy maximum of 2/3 of the volume

The inlet and outlet pipe should have T junction. This ensures that the scum and the settled solids are not disturbed due to incoming water or leaves the containment unit. The baffle wall ensures short circuiting of the path of the scum and solids to the outlet. The roof slab should be adequately thick. Minimum thickness of 100 mm is recommended. In cases where vehicular movement over the tanks is expected, the thickness of the slab should be increased. An opening should be kept in the roof slab which eases the desludging of the septic tank. The ventilation pipe extending at least 2 m above the ground level ensures that the methane gas generated due to anaerobic digestion of the solids is vented out of the tank.

## Key points

- Inlet and outlet pipes – T Pipe extending at least 250 mm into the liquid
- Baffle wall to be provided with opening or connecting pipe, height of opening 2/3 h from bottom
- Roof slab of at least 100 mm thickness with circular (500 mm) or rectangular opening (600 mm x 450 mm)
- Ventilation pipe- Extending at least 2 m above the ground level

The above slides give the standard dimensions as per the IS 2470 for Indian conditions. Although it is recommended to follow these standards for economical sizing of septic tank, most of the households build the septic tank of various shapes and sizes depending upon the constraints. This not only affects the efficiency of the sedimentation of solids, but also changes its desludging frequency. In cases where the septic tanks are not lined, the characteristics of the sludge changes significantly.

## Septic tank dimensions

No. of Users	Length (m)	Breadth (m)	Liquid depth (m) (cleaning interval of)	
			2 years	3 years
5	1.5	0.75	1.0	1.05
10	2.0	0.90	1.0	1.40
15	2.0	0.90	1.3	2.00
20	2.3	1.10	1.3	1.80

Note 1: The capacities are recommended on the assumption that discharge from only WC will be treated in the septic tank

Note 2: A provision of 300 mm should be made for free board.

Note 3: The sizes of septic tank are based on certain assumption on peak discharges, as estimated in IS: 2470 (part 1) and while choosing the size of septic tank exact calculations shall be made.

## Septic tank dimensions

No. of Users	Length (m)	Breadth (m)	Liquid depth (cleaning interval of)	
			2 years	3 years
50	5.0	2.00	1.0	1.24
100	7.5	2.65	1.0	1.24
150	10.0	3.00	1.0	1.24
200	12.0	3.30	1.0	1.24
300	15.0	4.00	1.0	1.24

Note 1: A provision of 300 mm should be made for free board.

Note 2: The sizes of septic tanks are based on certain assumptions on peak discharges, as estimated in IS: 2470 (Part 1) and while choosing the size of septic tank exact calculations shall be made.

Note 3: For population over 100, the tank may be divided into independent parallel chambers of maintenance and cleaning.

## Septic tank (more than 50 users)

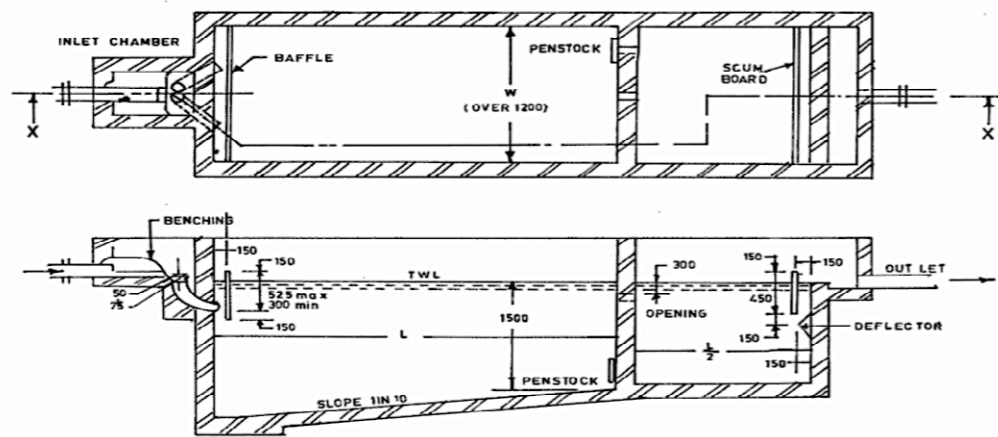

The above slides show typical plan and cross section of the septic tank for more than 50 users.

## Anaerobic baffled reactor

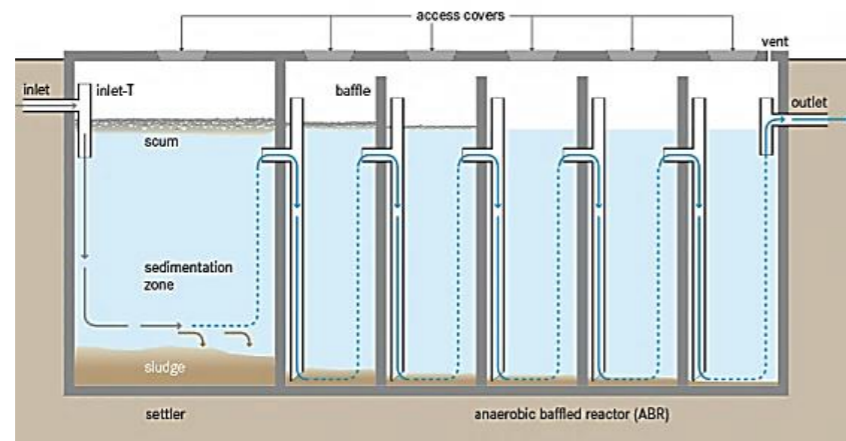

An anaerobic baffled reactor (ABR) is an improved Septic Tank with a series of baffles under which the grey-, black- or the industrial wastewater is forced to flow under and offer the baffles from the inlet to the outlet. The increased contact time with the active biomass (sludge) results in improved treatment. ABRs are robust and can treat a wide range of wastewater, but both remaining sludge and effluents still need further treatment in order to be reused or discharged properly.

## Anaerobic up-flow filter

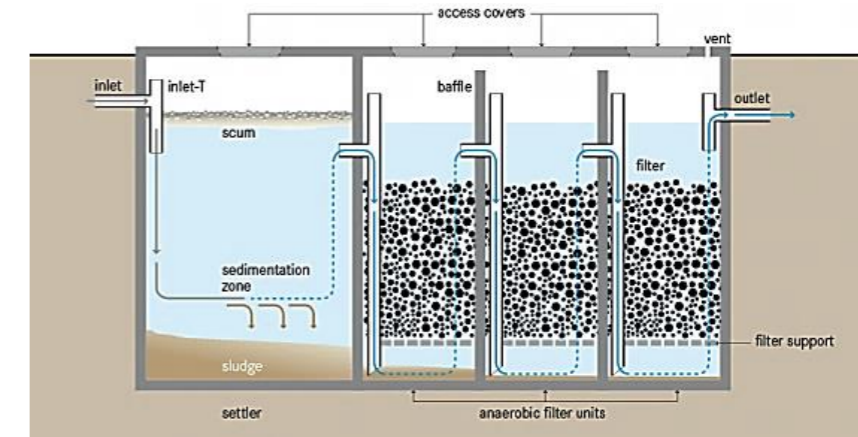

An anaerobic filter is a fixed-bed biological reactor with one or more filtration chambers in series. As wastewater flows through the filter, particles are trapped and organic matter is degraded by the active biomass that is attached to the surface of the filter material. Anaerobic filters are used as secondary treatment in household black- or greywater systems and improve the solid removal compared to septic tanks or anaerobic baffled reactors. Since anaerobic filters work by anaerobic digestion, they can be designed as anaerobic digesters to recover the produced biogas.

## Improving efficiency of containment units

- Use of active sludge for commissioning
- Desludging at regular interval
- Emptying only 2/3<sup>rd</sup> of the septic tank
- Having more baffled chambers
- Having more hydraulic retention time
- Attached growth micro organisms > Suspended growth micro organisms

To improve the efficiency of the septic tanks, active sludge is used as inoculant during the starting phase. This results in an immediate digestion of the settled solids. The desludging interval should be fixed. This should be practiced even if the existing septic tanks do not conform to standard design of septic tanks. While desludging of the septic tank, it should be kept in mind that 1/3<sup>rd</sup> of the septage/sludge should be left behind. Having more number of baffles (up to 3) helps in increasing the settling efficiency and treating the liquid effluent to some extent. Increasing hydraulic retention time upto 38 hours increases the efficiency of settling as well as treatment efficiency of the liquid effluent to some extent. It is well researched that attached micro-organisms have higher efficiency of treatment of wastewater. Hence in some cases, substrate is provided for the microorganisms to get attached to for further clarifying the water.

## Summary

- What are containment systems?
- What is the objective of the containment system?
- Types of containment systems
- Designing of septic tanks
- Improved containment systems

Session

**05**

# Emptying & Conveyance of Faecal Sludge & Septage

---

## Learning objectives

- To introduce technology options for emptying and conveyance
- To introduce different types of manually operated mechanical equipments and motorised emptying
- To introduce advanced technologies as mobile dewatering vehicles

## Contents

- Types of collection and transportation techniques
- Manual operated mechanical equipment
  - Sludge gulper
  - Diaphragm pump
  - MAPET
- Motorised emptying
  - Pit screw auger
  - Vacuum trucks
  - Vacu-tug
- Dewatering trucks

### 1. Types of Collection & Transportation techniques

## Types of Collection and Transportation

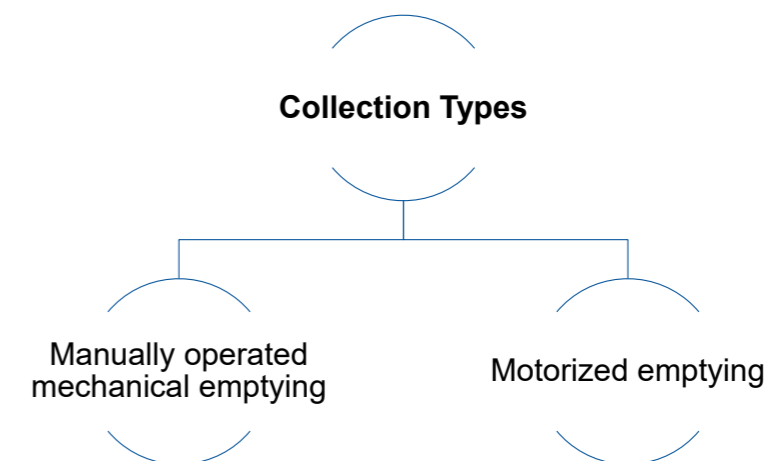

The collection and transportation techniques can be simply classified into two ways- manually operated mechanical emptying and motorized emptying. In the manually operated mechanical emptying mechanical equipment is manually operated to desludge the faecal sludge and septage from the septic tank, whereas in the later, completely mechanized system is used for empty the eptic tank.

## Manually operated mechanical emptying

- Manually operated pumps
- Low costs
- Availability of tools
- Little or no requirement of electric energy
- High health risk if not done properly

Manually operated mechanical emptying has manually operated pumps. This equipment is low cost and are made from locally available material. The equipment is small and easily maneuverable in small lanes. Little or no electricity is required for the desludging process. However, there is high potential health hazard if not done properly

### 2. Manually Operated Mechanical Equipment

#### Manually operated mechanical equipments

Sludge Gulper

Manually operated Diaphragm Pumps

MAPET

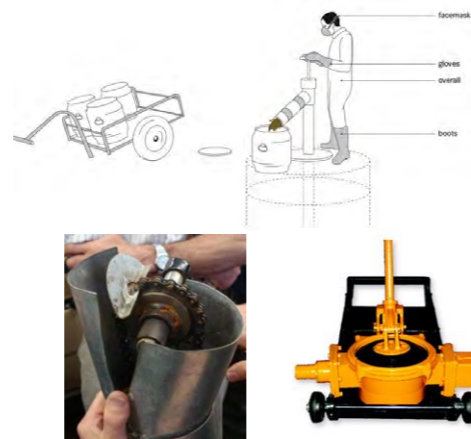

This section provides an overview of three of the most common types of manually operated mechanical pumping equipment that has been developed and trialed; namely, sludge gulper, diaphragm pump and the manual pit emptying technology (MAPET).

#### Sludge gulper



The Sludge Gulper was developed in 2007 by the London School of Hygiene and Tropical Medicine (LSHTM). It is a low-cost manually driven positive displacement pump that operates along the same principles as that of direct-action water pumps. The Gulper has a simple design, and can be built using locally available materials and fabrication techniques generally common in low-income countries. It consists of a PVC riser pipe containing two stainless steel ‘non-return’ butterfly valves. One valve, the ‘foot’ valve, is fixed in place at the bottom of the riser pipe and a second valve, the ‘plunger’ valve, is connected to a T-handle and puller rod assembly. As the handle is moved up and down, the two valves open and close in series and sludge is lifted up the riser pipe to exit the pump via a downward angled spout. A strainer is fitted to the bottom of the riser pipe to prevent non-biodegradable material from entering and blocking the pump.

Performance	Purchase/Operating Cost	Challenges
<ul style="list-style-type: none"> <li>• Suitable for pumping low viscosity sludges</li> <li>• Average flow rates of 30 L/min</li> <li>• Maximum pumping head is dependent on design</li> </ul>	<ul style="list-style-type: none"> <li>• Suitable for pumping low viscosity sludges</li> <li>• Average flow rates of 30 L/min</li> <li>• Maximum pumping head is dependent on design</li> </ul>	<ul style="list-style-type: none"> <li>• Difficulty in accessing toilets with a small superstructure</li> <li>• Clogging at high nonbiodegradable material content</li> <li>• PVC riser pipe prone to cracking</li> <li>• Splashing of sludge between the spout of the pump and the receiving container</li> </ul>

#### Manual diaphragm pump

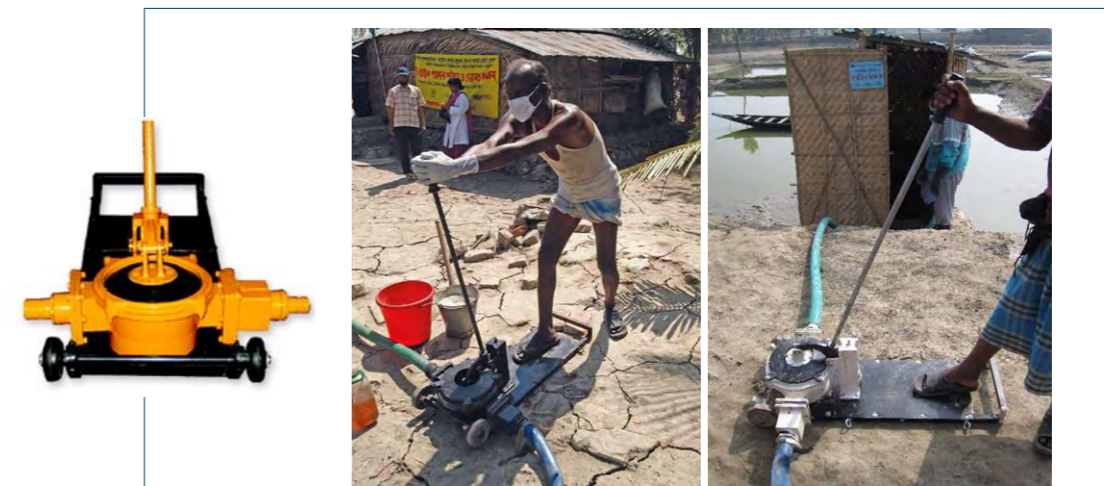

Manually operated diaphragm pumps are simple low-cost pumps capable of extracting low viscosity FS that contains little non-biodegradable materials. They typically consist of a rigid, disc shaped body clamped to a flexible rubber membrane called a diaphragm. An airtight seal between the diaphragm and the disc forms a cavity. To operate the pump, the diaphragm is alternately pushed and pulled causing it to deform into concave and convex shapes in the same way a rubber plunger is used to unblock a toilet. A strainer and non-returning foot valve fitted to the end of the inlet pipe prevents non-biodegradable material from entering the pump and stops backflow of sludge during operation respectively.

Performance	Purchase/Operating Cost	Challenges
<ul style="list-style-type: none"> <li>• Suitable for pumping low viscosity sludges</li> <li>• Average flow rates of 100 L/min</li> <li>• Maximum pumping head of 3.5m – 4.5m</li> </ul>	<ul style="list-style-type: none"> <li>• Capital Cost: INR 20,000 – INR 60,000 (depending on manufacturer and model)</li> <li>• Operating Cost: Unknown</li> </ul>	<ul style="list-style-type: none"> <li>• Clogging at high non biodegradable content</li> <li>• Difficult to seal fittings at the pump inlet resulting in entrainment of air</li> <li>• Pumps and spare parts currently not locally available</li> </ul>

## MAPET



In Tanzania, WASTE organization developed and trialed a human-powered vacuum system for the collection and short-distance transport of sludge called the Manual Pit Emptying Technology (MAPET). The MAPET is both the earliest and the most technically advanced manually driven mechanical collection system. It has two separate components, a pump and a 200-liter vacuum tank, each mounted on a dedicated pushcart.

Performance	Purchase/Operating Cost	Challenges
<ul style="list-style-type: none"> <li>• Maximum flow rates of between 10 and 40 L/min depending on the viscosity of the sludge and the pumping head</li> <li>• Maximum pumping head of 3 m</li> </ul>	<ul style="list-style-type: none"> <li>• Capital Cost: INR 2,00,000 (1992) (depending on manufacturer and model)</li> <li>• Operating Cost: INR12,000/annum (Maintenance cost)</li> </ul>	<ul style="list-style-type: none"> <li>• Requires strong institutional support for MAPET service providers</li> <li>• A reliance on the importation of a key spare part</li> <li>• MAPET service providers unable to recover maintenance and transport costs from emptying Fees</li> </ul>

## 3. Motorized Emptying

### Motorized emptying

Pit Screw Auger

Vacuum Trucks

Vacutug



Fully mechanized technologies are powered by electricity, fuel or pneumatic systems. They can be mounted on a frame or trolley for increased mobility, or mounted on vehicles for emptying and transporting large quantities of sludge over longer distances. This section introduces a range of fully mechanized technologies. It includes equipment that is widely available such as motorized pit screw auger, widely used vacuum truck or vacutug.

### Jalodbust

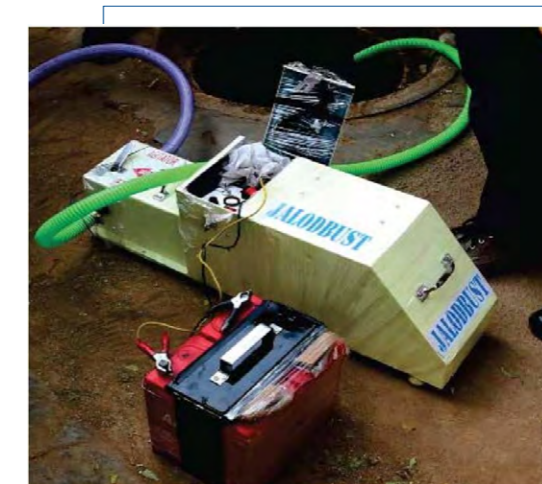

Jalodbust is a motorized emptying device which works on the piston pump principle. It is manufactured by JALODBUST. The equipment is portable, battery operated and is a sanitary sludge handling machine with agitator. The working principle of the agitator is based on the shock wave principle where the displacement is done by the movement of the piston. There is a gland to keep it water tight and a lever is used to create shock waves for agitator. It can produce up to 400 psi water jet to clean sewer blockages and it liquifies sludge by removing limiting viscosity. Some product specification are as follows:

- Can desludge 500-800 litres per hour
- 2500 litres can be desludged per battery charge
- 50 m horizontal distance and 10 m vertical lift
- The machine weighs 30kgs
- 24-volt 40 AH Battery
- 200-500-watt motor



## Pit screw auger



Motorized pit screw augers (SAS) are based on the Archimedean screw design. Motorized SAS are currently under development with prototypes which consist of an auger placed inside a plastic riser pipe and protruding by approximately 5 to 15 cm from the bottom end of the pipe. An electric motor is mounted on top of the riser pipe where it connects to the auger. To operate, the riser pipe is placed in the FS and as the auger turns, FS is picked up by cutting blades at the bottom of the auger and lifted up the riser pipe along the auger flights. A downward angled spout at the top of the riser pipe allows material to be discharged into a collection container. Weighing between 20 and 40 kg, motorized SASs can be operated by one person.

Performance	Purchase/Operating Cost	Challenges
<ul style="list-style-type: none"> <li>Can handle liquid sludge and a small amount of non-biodegradable waste</li> <li>flow rates of over 50 L/min. pumping head of at least 3m (difficulty emptying from variable depths)</li> </ul>	<ul style="list-style-type: none"> <li>Capital Cost: INR 45,000 – INR 50,000</li> <li>Operating Cost: Unknown</li> </ul>	<ul style="list-style-type: none"> <li>The fixed length of the auger and riser pipe</li> <li>Unsuitable for use with dry sludge and large quantities of non-biodegradable waste</li> <li>Difficult to clean after use</li> <li>Difficult to manoeuvre due to weight and size</li> </ul>

## Vacuum trucks

- Vehicle equipped with motorized pump and a storage tank often called as Vacuum Truck.
- Fast and efficient.
- Capacity 3 – 12 m<sup>3</sup>
- Cost of 3 m<sup>3</sup> vacuum truck: starts from 8 – 12 lakhs.



TRAILER SUCTION MACHINE



TRUCK-MOUNTED SUCTION MACHINE

Pumping systems that utilize a vacuum have been shown to be effective at removing FS from onsite water-retaining systems. Vacuum pumps may be mounted on heavy duty trucks or trailers, on lighter duty carts or even on human powered carts when smaller volumes are being collected, or for use in dense urban settings not accessible by larger trucks. Vacuum pumps often utilize the truck's transmission to power the system, although independently powered, dedicated motors can also be used. Vacuum trucks are available in a wide variety of sizes and models to accommodate different needs, with the most commonly used in India having capacities ranging from 3000 litres to 12,000 litres.

## Selection of Vacuum Trucks

- Typical volume of the tanks or vaults that will be serviced
- Road widths and weight constraints
- Distance to the treatment plant
- Availability
- Budget and
- Skill level of the operators.



Vacuum pumps are sized based on lift elevation, pumping distance, volume of sludge to be removed, and the volume of the tank. When designing collection and transport systems, local manufacturers should be consulted in order to determine what equipment is available. Product specifications must be checked to verify that the proposed truck is adequate for the need. Various factors influence the selection of a vacuum truck by a service provider, including:

- Typical volume of the tanks or vaults that will be serviced;
- Road widths and weight constraints;
- Distance to the treatment plant;
- Availability;
- Budget; and
- Skill level of the operators.

## Components of Vacuum Trucks

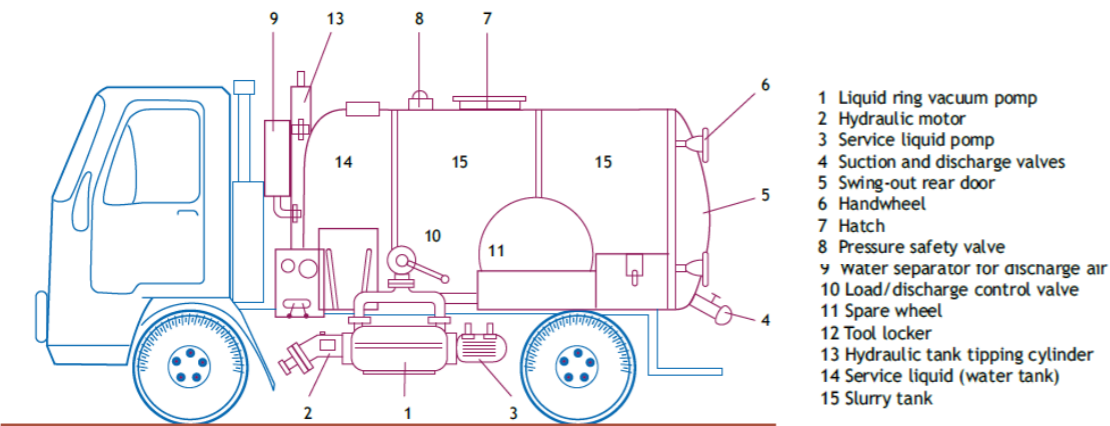

Vacuum truck is a most sophisticated equipment which is widely used for desludging of containment systems such as septic tanks. The vacuum trucks come in different sizes and types. As shown in the picture, an improved version is a truck mounted tank fitted with the vacuum pump. In this case there is possibility that the vacuum pump can be coupled with the drivetrain of the truck, thus eliminating the need of separate diesel run motor. In other simpler case, trailer mounted tank with vacuum pump is the basic equipment where the trailer can be tugged with tractor and the vacuum pump is operated using diesel run motor. Now-a-days, vacuum trucks fitted with jetting equipment is also available for cleaning sewerage network and manholes.

## Vacuum Pumps

### Vacuum pumps

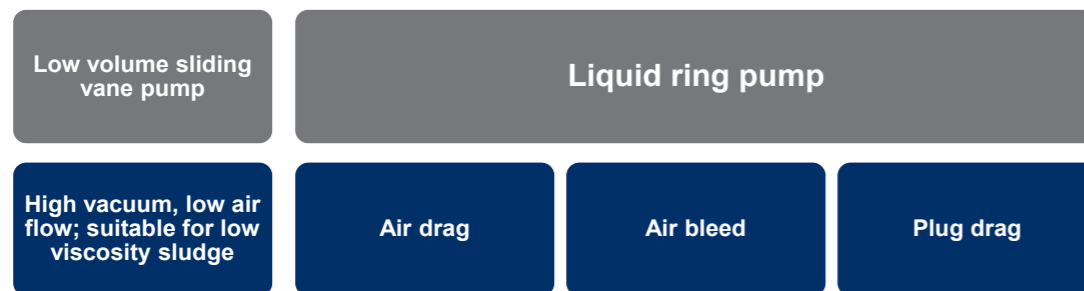

Conventional vacuum tankers are typically fitted with either a relatively low cost, low-volume sliding vane pump or a more expensive liquid ring pump. The former is more appropriate for low-capacity vacuum tankers where high vacuum and low airflow sludge removal techniques are used. Vacuum conveyance techniques work best for removing low-viscosity sludge such as that found in septic tanks.

## Vacuum Types

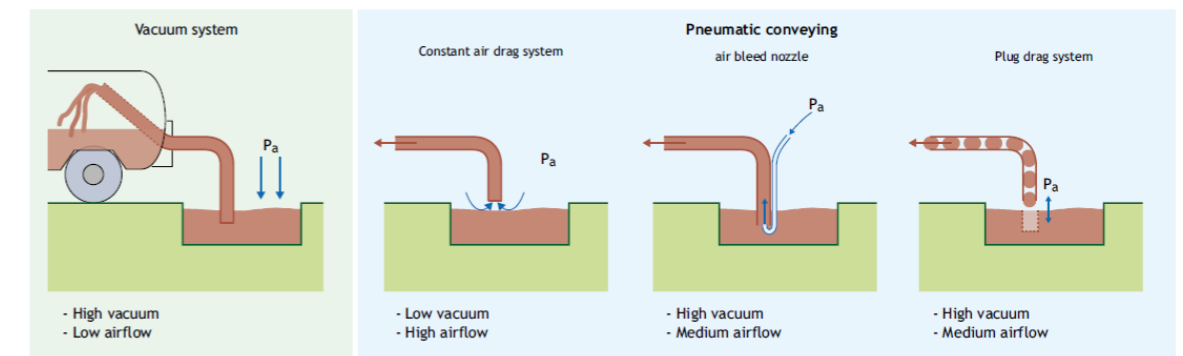

Liquid ring pumps are more appropriate for high-capacity vessels and pneumatic conveying techniques. Three such techniques namely, constant air drag, air bleed, and plug drag, are briefly described in figure. They are most suitable for emptying higher viscosity sludge typically found at the bottom of a septic tank or in a pit latrine.

## Advantages and Disadvantages

Advantages	Disadvantages
<ul style="list-style-type: none"> <li>Fast, hygienic and effective sludge removal</li> <li>Efficient transport possible with large vacuum trucks</li> <li>Potential for local job creation and income generation</li> <li>Provides an essential service to un-sewered areas</li> </ul>	<ul style="list-style-type: none"> <li>Cannot pump thick, dried sludge</li> <li>Garbage in pits may block hose</li> <li>Very high capital costs; variable operating costs depending on use and maintenance</li> <li>Hiring a vacuum truck may be unaffordable for poor households</li> <li>Not all parts and materials may be locally available</li> <li>Improper discharge of the collected sludge could generate public health and environmental problems</li> </ul>

## Accessibility!

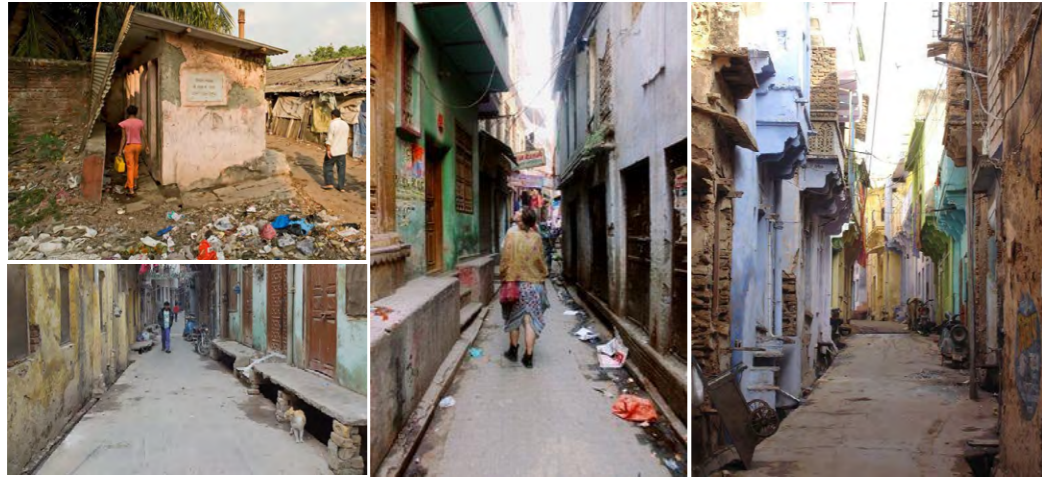

This slide represents the accessibility situations in old urban areas or slum areas where emptying the containment system is the big challenge.

## Vacutug - I

- Self driving 4 wheeler
- Engine powers both the pump and drive train
- Tight turning radius, easy to manoeuvre
- Vertically mounted sludge collection tank
- Suitable for use on narrow streets



Tank capacity	Pump	Engine	Max speed
700 L	MEC 2000/P	10.5 hp diesel	5 kmph

Vacutug is a smaller version of the trailer mounted type of vacuum truck. The need of such a smaller size desludging equipment arises from the fact that not all the containment units are easy to access. Especially in the unorganized settlements such as urban slums, the access roads are small and a vacuum truck cannot be driven to the household. Hence, vacutug is used to empty the content of the septic tank in batches and empty it into the bigger truck. The tugs can be as small as 300 kilo-litres. The most important thing which makes a vacutug is to keep in mind that it should be easy enough to pull it by persons or vehicles.

## Vacutug - II

- 2 wheeler trailer unit
- Towed by tractor or large pick up truck
- Horizontally mounted sludge collection tank
- Suitable for use on wide streets and highways



Tank capacity	Pump	Engine	Max speed
2000 L	MEC 2000/P	12 hp diesel	45 kmph

## Vacutug - III



- 3 wheeler unit
- Engine powers both the pump and drive train
- Tight turning radius, easy to manoeuvre
- Vertically mounted sludge collection tank
- Suitable for use on narrow streets and highways

Tank capacity	Pump	Engine	Max speed
700 / 2000 L	MEC 2000/P	12 hp diesel	30 kmph

## Vacutug - IV



- 4 wheeler trailer unit
- Horizontally mounted sludge collection tank
- Top cover conceals engine & pump
- Cargo deck sides fold down
- Suitable for narrow streets and long distances

Tank capacity	Pump	Engine	Max speed
1000 L	MEC 2000/P	12 hp diesel	70 kmph

## 4 Transfer Station

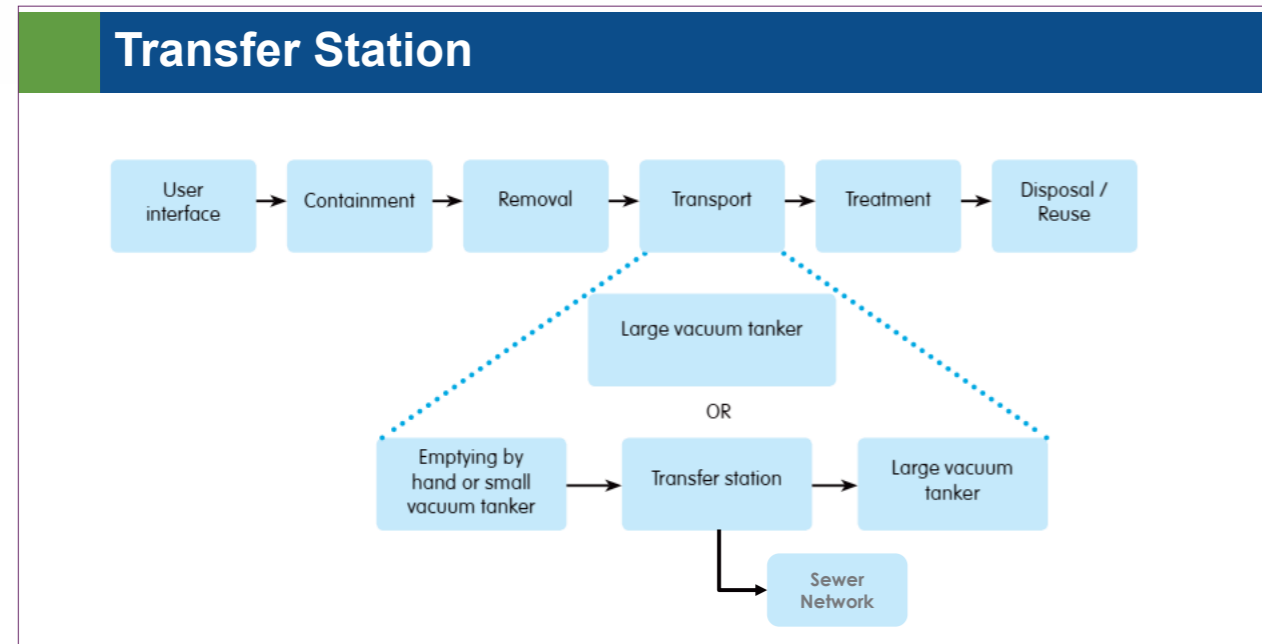

The location of formal/regulated disposal sites are often far out of town and therefore operators are required to travel long distances to dispose of the septage. These long distances result in high fuel costs for the trucks (which is the largest operating expense for them), and hence it also means higher emptying fees for the households due to truck operators charging higher rates for the longer distances they have to travel. For example, in one of our study in Uttarakhand we have come across a case where a private operator near New Tehri city is providing emptying service to the nearer towns or villages and transporting FSS to the STP at New Tehri for co-treatment. He was charging INR 10000 for emptying and transporting FSS from a town which is around 15 – 20 km away from the STP. Which is in a way not feasible to the households.

In a study, it has also found that distances from the emptied septic tank to a regulated disposal facility of greater than 5 – 10 kms often result in illegal dumping of FSS in low lying areas or nalla's or in rivers. In order for operators to get enough trips done in a day, while keeping the service affordable, has resulted in this illegal practice, which has obvious health and environmental issues.

One of the option / solutions to these issues is installation of transfer station. There can be different approaches for setting up of transfer stations

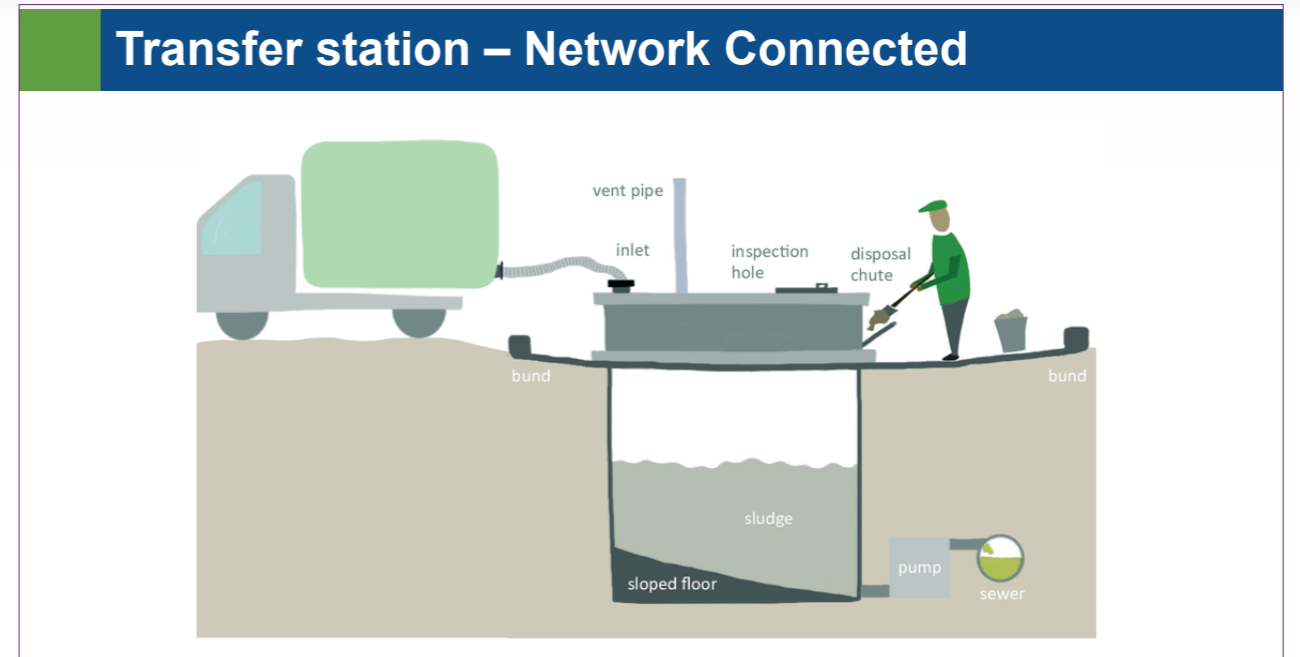

In a case, where we have to consider the co-treatment approach, we can think of network connected transfer station.

**Network-connected station:** The sewer discharge station (SDS) is much the same as the simple transfer station, but is directly connected to a conventional gravity sewer main so that the septage can be transported to a semi-centralized secondary treatment system, as shown in figure 9. This avoids the need for the septage to be carted away by a larger vacuum tanker.

A variation on this option, is to use existing sewer lifting stations as septage transfer stations, where the septage is discharged directly into the wet well of the pumping station. These options are only viable where septage (sludge with a high liquid content) is retrieved from septic tanks and disposed in the transfer station. Utilities and asset owners discourage the disposal of concentrated sludge directly into the sewers as it can lead to blockages, especially if the sludge is too dry (Strande et al. 2014).

Septage emptied into the SDS is released into the sewer main either directly by gravity or at timed intervals (e.g., by pumping) to optimize the performance of the sewer and of the wastewater treatment plant, and/or reduce peak loads (Tilley et al. 2008).

The slope of the floor should ensure that the sludge gravitates towards the outlet pipe and is discharged to the sewer.

## Transfer station – Modular

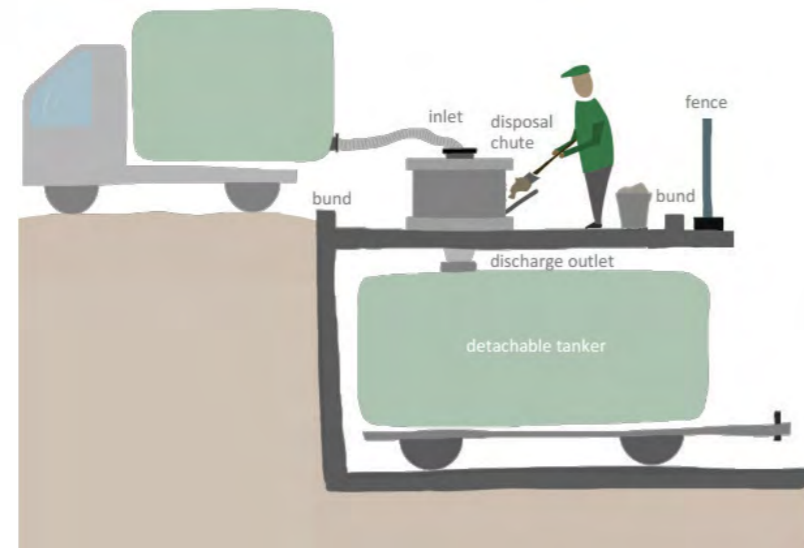

6

Modular transfer station allows easy access for the disposal of the sludge into the portable container by smaller vacuum tankers or manual operators, a raised platform may need to be constructed. Figure 7 shows how a detachable tanker, for example, can be parked under a raised platform. Septage is discharged into the top of the tanker. When the tanker is full, it is replaced with an empty one, and the full one is transported for emptying at a legal dumping site.

## Transfer station - Mobile

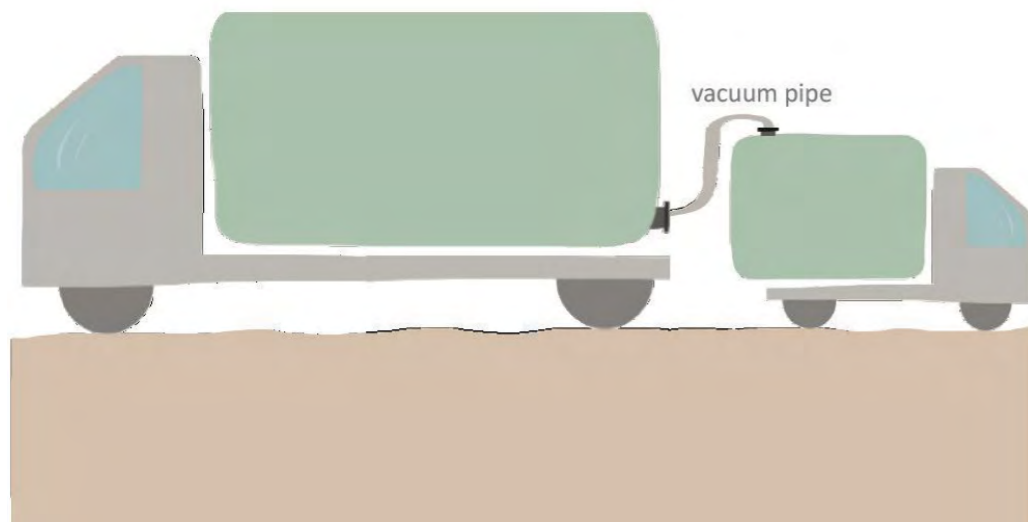

Mobile transfer stations consist of easily transportable containers providing temporary storage capacity at any point near the structure being emptied - essentially a tank fitted on a wheeled chassis. Examples of such transfer stations include motorised collection vehicles, or tanker trailers pulled via a truck or tractor.

The stations are sited in any area where multiple trips by small-scale transport equipment are

required. The main advantage of these stations is that they sidestep the complex and often lengthy procedures required for siting fixed stations in high-density settlements. They can also double as secondary transport containers once full as they can be easily driven or towed to the final disposal site.

If towed, the motorised vehicle towing the container is capable of performing other related or unrelated duties thus allowing for cost savings and potential for increased revenue. Such systems have reportedly been used in places such as Maseru, Lesotho (Strauss and Montangero, 2002).

## 4 Dewatering Trucks

### Dewatering truck

- Sludge is more than 95% water.
- Water is heavy and occupies volume
- Dewatering trucks
  - Conditions the sludge
  - Dewater the sludge- up to 75%-85% removal of liquid
  - The filtrate goes back into the septic tank
- Up to 10 times more service possible



www.pumper.com

Dewatering truck is a vacuum truck which desludges the septic tank and simultaneously separates the solids from the septage. The filtered water can be put back into the septic tank as its characteristics are much better than the septic tank effluent. The separated solids now have significantly less volume and weight less. Thus it not gives an opportunity to service more households but also improves the fuel efficiency of the truck.

### Summary

- Types of different emptying and conveyance equipment
- Vacuum trucks is most popular and safest way to empty and convey the FSS
- Vacu-tug is good option for the households having narrow lanes
- Dewatering trucks is a viable option for decreasing the emptying and conveyance cost

Session

**06**

# **Treatment Mechanism for Faecal Sludge & Septage**

---

## Learning objectives

In this session we will realise the treatment targets and treatment mechanisms which can be used for treatment of treating faecal sludge and septage.

The objective of finance session is to emphasize on sustainability of FSSM services. It gives an overview on assessment of financial requirements and potential sources of finance for capital costs and O&M expenditures for implementing an FSSM plan in a city.

## Contents

- Treatment targets
- Physical mechanisms
  - Screening
  - Gravity separation
  - Filtration
  - Evaporation & evapotranspiration
  - Heat drying
- Biological mechanisms
  - Aerobic treatment
  - Composting
  - Anaerobic treatment
  - Pathogen reduction
- Chemical mechanisms
  - Alkaline stabilisation
  - Coagulation and flocculation
- Treatment concerns

### 1. Treatment Targets

## Treatment target

- To ensure protection of human and environmental health
- Need of regulations for treatment and discharge, enduse or disposal of FSS is essential
- Regulations are usually borrowed and should be developed for local context
- Treatment target should be developed based on enduse/disposal of bio solids and effluent

The larger treatment objective of any kind of waste is protection of human and environmental health. For achieving this target, one needs regulations for treatment and discharge standards for enduses or disposal of the end products.

Regulations such as that for solids have been borrowed from USEPA and WHO standards for bio solids and are considered as guidelines. The regulations as well as the targets should be curated in a way that it promotes enduses of the treatment products. Only in this way we can ensure that complete treatment of faecal sludge and septage is achieved.

## Specific treatment objectives

- Reduce the water content of the sludge
- Reduce the oxygen demand and suspended solids content of the liquid fraction
- Reduce the pathogens from the liquid effluent
- Reduce the pathogen concentrations in solids

The specific treatment objectives of faecal sludge and septage treatment are; (a) to reduce the water content of the sludge thus making it easier to work with and transport, (b) to reduce the oxygen demand and suspended solids of the liquid fraction that is discharged to the environment to the point at which discharging it to watercourses will not deplete oxygen levels, (c) to reduce the pathogens from the liquid effluent so as to allow safe disposal or end use, (d) to reduce the pathogen concentration in the solids so as to allow its safe enduses or disposal.

## Treatment Mechanisms

### Physical Mechanisms

Used for solid liquid separation.  
Objective if to reduce the SS in order to reduce oxygen demand.  
Ensures smoother functioning of other electro mechanical equipment such as pumps.

### Biological Mechanisms

Used for stabilization and liquid treatment.  
Objective is to reduce organic content thereby reducing the oxygen demand.  
Required for meeting the discharge regulations for treated wastewater.

### Chemical Mechanisms

Used for stabilization and pathogen inactivation.  
Objective is to partially digest the sludge, reduce the pathogens.  
Chemicals are also used to condition the sludge for mechanical dewatering.

**Treatment units employ one or more treatment mechanisms for achieving the treatment objectives.**

## 2. Physical Mechanisms

### 1. Physical mechanisms

- Dewatering- the most important treatment objective.
- Water is heavy and expensive to transport!
- Water in FS is available in “bulk” or “bound” forms.

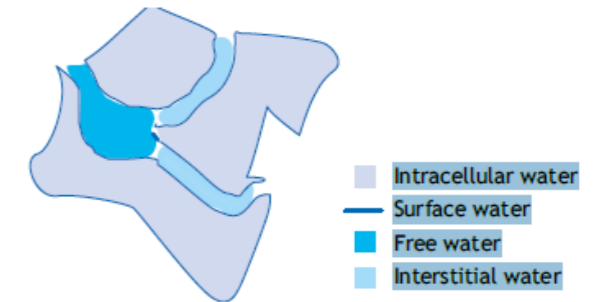

Physical mechanisms are usually used in faecal sludge and septage treatment for reducing the water content of it. Water is heavy and expensive to transport and is not an actual interest for the faecal sludge treatment plant.

Water is present in faecal sludge and septage in mainly two forms- bulk and bound form. The free water shown in the diagram is called bulk water whereas the interstitial, surface and intracellular water is called bound water. Bulk water is easy to dewater using gravity separation.

### 1.1 Screening

- Physical exclusion of solid waste (not solids!) from the FS.
- The flow of the FS should be between 0.3 m/s and 1.0 m/s.

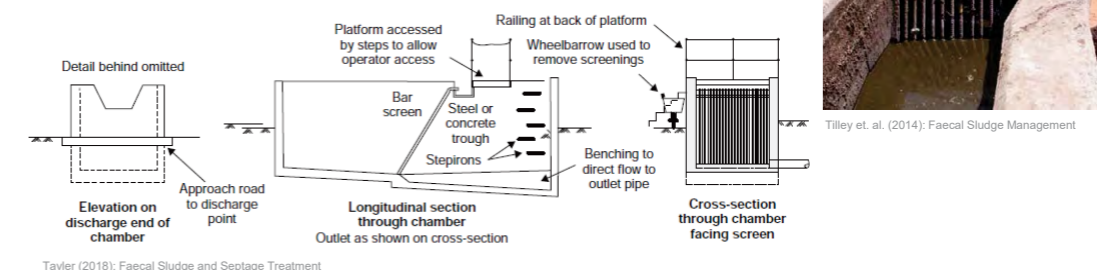

Screening of faecal sludge and septage is necessary to arrest the solid waste which might be disposed off in the toilet. Solid waste such as sanitary pads, diapers, condoms and plastic bags are commonly found waste in septage. It is important to remove this waste from the sludge as it may clog the pipes or pumps or disrupt the treatment processes. The velocity of the faecal sludge – septage should be between 0.3 m/s and 1.0 m/s. The velocity of 0.3 m/s ensures self-cleansing velocity in the channel leading to the screens whereas the velocity of 1.0 m/s ensures that the solid waste is not pulled through the bars due to the strength of flow. Usually coarse screens are usually used for screening, however, second fine screen can be used in certain cases where deemed necessary.



## 1.2 Gravity separation

- Most commonly employed method.
- Based on size of the particles, suspended solids concentration and flocculation.
- **Settling mechanisms**
  - Discrete particle
  - Flocculent
  - Hindered
  - Compression

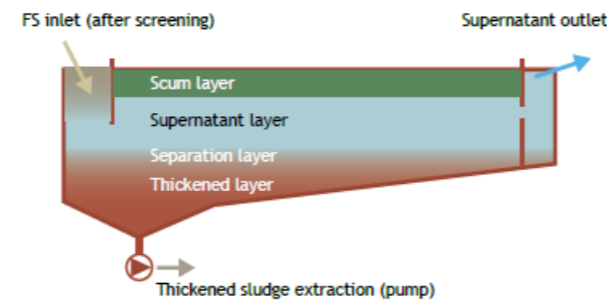

Gravity separation is based on the fact that solids in the faecal sludge and septage have different specific gravity when compared to water. Oil grease fats also gets separated because they have less specific gravity as compared to water. Hence when the water is retained, gravity separation occurs naturally. Gravity separation is achieved using simple settling thickening tanks as shown in the figure.

## 1.3 Filtration

- Filtration media- Membrane, granular
- Types- slow, rapid, pressurized
- For FS- planted and unplanted drying beds!

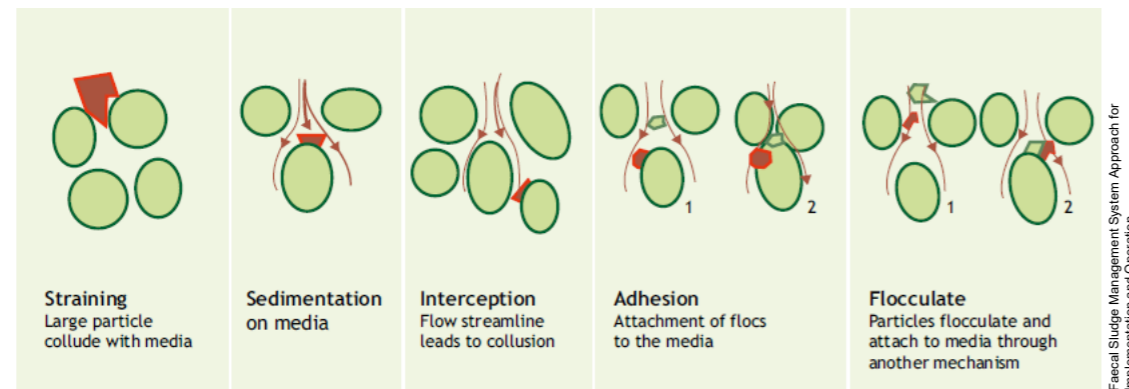

Filtration is a process based upon the physical size of the solids when compared to that pores in the filter media. Physical exclusion can be achieved using filtration media such as membrane (geotubes) or granular (sludge drying beds). Filtration can be classified as slow, rapid and pressurized depending upon the environment in which filtration is achieved. Usually in case of faecal sludge and septage, slow filtration is used. In the other two types of filtration processes, there are high chances of clogging when used of septage.

In addition to physical mechanisms, chemical and biological processes also occur within the filter. Chemical processes include attraction processes that result in flocculation or adhesion to filter surfaces. Biological growth happens throughout the filter, but tends to be more intense near the surface, depending on the presence of oxygen, carbon sources and nutrient availability. This can also result in biological removal of nutrients and BOD occurring within the filter.

## 1.4 Evaporation & Evapotranspiration

- Evaporation- Release of water into the air as vapour.
- Evapotranspiration- Evaporation + release of water vapour into air by plants.
- Rate is dependent on;
  - climatic conditions,
  - heat
  - moisture content
  - wind speed



Faecal Sludge Management System Approach for Implementation and Operation

Evaporation and evapotranspiration is used for reducing the bound water of the sludge. In case of unplanted drying beds and geo tubes, evaporation is achieved by exposing the solids to sunlight or by forced evaporation using solar drying houses. In case of planted drying beds, the same is achieved using evapotranspiration. Planted drying bed also stabilize the sludge to some extent when designed and operated properly. The rate of evaporation and evapotranspiration is largely dependent on climate, heat, moisture content and wind speed at the treatment facility.

## 1.5 Heat drying

- Used to evaporate and dewater sludge beyond what can be achieved by passive methods.
- Achieves reduction in volume as well as weight.
- Involves either conduction, convection, radiation or combination of these processes.

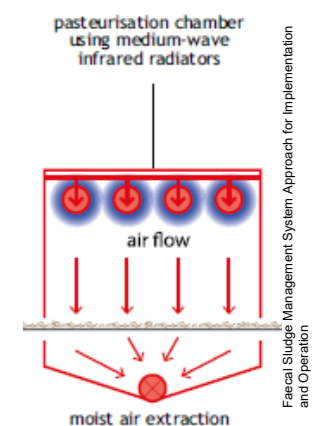

Heat drying refers to application of heat to reduce the water content of the sludge. Usually heat application is done after dewatering i.e. after freeing the sludge from bulk water. Heat drying achieves significant volume as well weight of the sludge. Heat application can be done using conduction, convection, radiation or combination of these processes. The quantity of heat that needs to be applied depends on the specific heat capacity of the sludge or in simple words the water content of the sludge. Specific heat capacity is measured in kJ/kg/oC. Specific Heat Capacity of Water at 25oC is 4.18 kJ/kg/oC. For wastewater sludge it is reported to be 1.95 kJ/kg/oC.

### 3. Biological Mechanisms

## 2. Biological mechanisms

- Transformation of organic matter and nutrients.
- Harness the metabolism and growth rate of microorganisms- in controlled situations to optimise desired outcomes.
- Stabilisation- degradation of putrefiable, readily degradable material, leaving behind more stable, less degradable organics.

This is important in order to reduce the oxygen demand, produce stable and predictable characteristics, reduce odours, and allow for easy storage and manipulation. ‘Stabilised’ organic matter does not have an exact agreed upon scientific definition, but in general refers to resistance to further biodegradation. Stabilised sludge consists of particles like cellulose, lignin, inorganic matter, and cellular matter of microorganisms that consumed readily degradable organics, whereas unstabilised sludge contains easily degradable compounds such as carbohydrates, proteins, and sugars. Volatile solids are used as a measure for stabilisation, as they are considered to be composed of readily degradable organic matter.

## 2.1 Aerobic treatment

- Aerobic environment refers to the presence of oxygen.
- Aerobic organisms rely on oxygen for their respiration.
- Aerobic treatment processes in wastewater treatment are activated sludge, sequencing batch reactors, trickling filters etc.
- Solubility of oxygen in FS is low, hence aeration can be energy intensive.



Source: Almaxeco



Source: Fuchs-Germany

Aerobic treatment consists of aerobic degradation of organic solids. Aerobic digestion of the solids needs supply of external oxygen and hence becomes costly when compared to anaerobic digestion. Aerobic digestion of the organic solids is usually used in wastewater treatment and is not recommended for stabilisation of faecal sludge and septage.

## Composting

Composting process is controlled using;

- C:N = 20-30
- Moisture content: 40-60%
- Oxygen content: free pore space of 20% by volume.
- Cycle time: up to 4 weeks
  - Mesophilic stage: 5 days
  - Thermophilic stage: 10 days
  - Maturation stage: 15 days

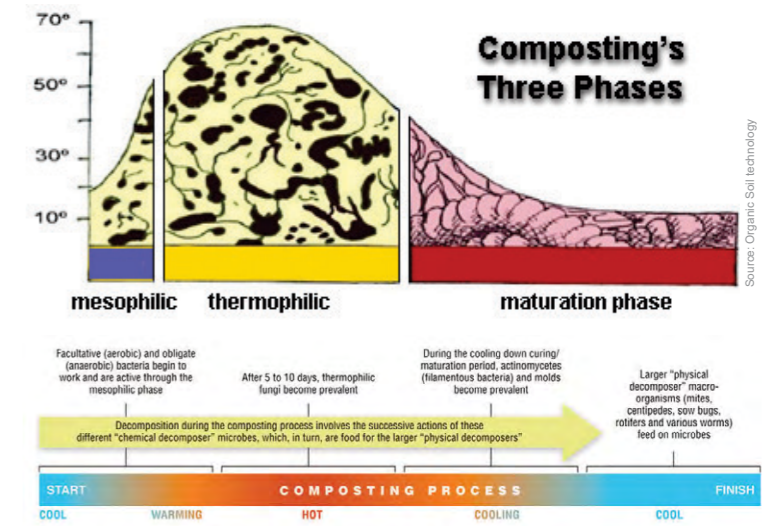

During the first phase, bacteria are growing rapidly while consuming readily degradable compounds (e.g. sugar, starch, protein). During this period, the temperature is also increasing due to the rapid rate of growth (due to exothermic catabolic reactions), which is faster than the rate at which heat can escape. In the second phase, thermophilic temperatures of 50-75°C are achieved and thermophilic bacteria become active, further decomposing the organic matter. During this phase pathogen reduction and inactivation of plant seeds (e.g. weeds) occurs as a result of the high temperatures. In the third phase, stabilisation is being reached as the last of the readily degradable substrates are depleted, bacterial activity slows down, and the temperature lowers.

## 2.3 Anaerobic treatment

- Used for stabilising of FS, produces biogas!
  - Complex chemistry consisting of three stages
1. Hydrolysis
  2. Acidogenesis
  3. Acetogenesis
  4. Methanogenesis

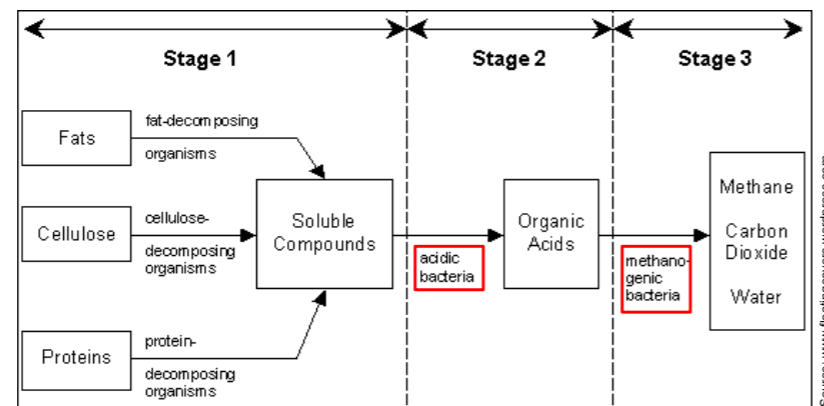

Anaerobic treatment refers to anaerobic digestion of organic solids. Anaerobic digestion happens in three stages. The first stage is called hydrolysis where complex organic material breaks down into soluble compounds. These compounds are then converted into different types of acids by two processes called acidogenesis and acetogenesis. Further in the third stage the acids are transformed into stable compounds such as methane, carbon dioxide and water by a process called methanogenesis. Anaerobic digestion is recommended in sludge stabilisation as it is more economical as compared to aerobic digestion.

## 2.4 Pathogen reduction

- Temperature: pathogens are inactive above 60°C
- Sorption: 50% helminth eggs separate during settling, up to 90% are retained in the sludge in drying beds.
- Dessication: dehydration reduces the activity of pathogens.
- UV: Solar/ UV radiation (300-400 nm) inactivates the pathogens.
- pH: Microorganisms survive and grow in neutral conditions and can withstand range of 2-3 pH units

Pathogen reduction is achieved using five ways;

- **Temperature-** Pathogens when exposed to a temperature above 60 °C makes them inactive as they cannot survive at these temperatures,
- **Sorption-** Helminth eggs (one kind of pathogen in faecal sludge and septage) has a tendency to be attached to the solids. So when solids are separated using settling or filtration, helminth eggs are also eliminated from the liquid fraction.
- **Desiccation-** this refers to dehydration of pathogens and is achieved by drying out the solids completely. In absence of moisture pathogens become inactive.

- **UV-** Exposing the pathogen to UV rays breaks their cells and makes them inactive. However, for efficient pathogen reduction using UV, the solids content should be reduced significantly i.e. to less than 50 mg/L.
- **pH-** Pathogens cannot survive in extreme pH conditions. Hence by manipulating the pH of faecal sludge and septage, helps to reduce the pathogens.

## 4. Chemical Mechanisms

### 3. Chemical mechanism

- To improve the performance of other physical mechanisms,
- To inactivate pathogens in FS,
- To stabilise the FS.
- Addition of chemical increases the cost of treatment, hence “cost-benefit analysis” needs to be done!



Chemical mechanisms refer to use chemicals to either enhance the performance of physical mechanisms, to inactivate the pathogens or to stabilise the faecal sludge. Since chemicals used in liquid treatments are quite expensive, a proper cost benefit analysis is required before resorting to the use of chemical mechanisms.

### 3.1 Alkaline Stabilisation

- Used for stabilisation of FS.
- Addition of lime;
  - Raises the pH to 12, ceases microbial activity.
  - Results in odour and pathogen reduction.
- Addition of quick lime;
  - Raises the temperature up to 60 °C.
  - Inactivates Helminth eggs too!
  - pH lowers down, hence excess Lime addition is needed.



Alkaline stabilisation as the name suggests helps to stabilise the faecal sludge and septage. It can be achieved using lime or quicklime. When lime is mixed with faecal sludge or septage, it raises the pH of the mixture to 12. The pathogens do not survive in such extreme alkaline conditions. This process not only stabilises the sludge but also reduced odour and increases the settleability of the solids.

When quick lime is mixed with faecal sludge or septage, it rapidly reacts with the water. This is an exothermic process which raises the temperature of the moisture upto 600C. This also results in reduction in pH of the mixture. Both these factors lead to not only stabilisation but also pathogen reduction. In cases where pH drops below the desired values, addition of lime is required.

## 3.2 Coagulation and flocculation

- Removal of colloidal particles through gravity settling.
- Polymers can be natural or synthetic based chemicals.



Coagulation and flocculation refers to the chemical treatment mechanism where in chemical is used to achieve flocs of sludge which are then easy to remove using gravity settling or mechanical dewatering process. The commonly used chemicals for coagulation and flocculation are ferric chloride, alum or lime. Now-a-days a complex mixture of polymers is also available which are highly effective in coagulation of sludge. These are mostly used in cases where direct dewatering of septage is done using mechanical dewatering equipment.

## 5 Treatment Concerns

### Treatment concerns

- Source of faecal sludge and septage needs to be monitored
- Heavy metals cannot be removed during treatment
- Sludge from industries need to be handles separately
- Filtrate from the sludge drying bed and stabilisation pond can be alkaline
- Monitoring of end products is must!

The treatment concerns are as follows;

- The characteristics of faecal sludge and septage can be gauged by knowing its source.
- Heavy metals are not intended to be present in the faecal sludge and septage from households. Hence none of the treatment mechanisms described in this session will remove the heavy metals from the sludge.
- Sludge from the industries is a complex mixture of chemicals with varying pH, temperature and constituents specific to the industry. Hence, the sludge from industries need to be treated separately.

- Filtrate from the sludge drying beds and stabilisation ponds can be alkaline in nature and its pH needs to be adjusted before proceeding ahead with liquid fraction treatment.
- Quality of the end products needs to be monitored. This ensures that all the treatment processes are monitored indirectly.

## Summary

- Treatment target needs to be set depending upon local context
- Treatment mechanisms are same as that of wastewater treatment
- Source of FSS needs to be checked as heavy metals cannot be removed during treatment
- Monitoring of end products is necessary

Session

**07**

# **Selection of Faecal Sludge & Septage Treatment Mechanisms**

---

## Learning objectives

In this session we will be looking deeper into the specific treatment objectives of faecal sludge and septage treatment.

The treatment facility consists of number of treatment mechanisms. Selection of appropriate treatment mechanisms is important for sustainability of the treatment technology.

# Contents

### Treatment objectives

- Dewatering
- Pathogen removal
- Nutrient recovery
- Stabilisation

### Approaches for FSSM

### Selection of treatment mechanisms

- Treatment performance
- Local context
- O&M requirement
- Cost

## 1. Treatment Objectives

### Treatment objectives

#### DEWATERING

- Reduction of design capacities
- Simplifies treatment scheme
- Gravity settling or filter drying beds
- Dewaterability of faecal sludge and septage

#### • Adding dry material to increase solid content

- Pyrolysis
- Co composting

#### • Liquid fraction – high in ammonia, salts and pathogens

One of the very important treatment objectives of faecal sludge and septage is dewatering. Dewatering helps to reduce the volume of sludge to be handled and treated using other treatment mechanisms, hence it reduces the CapEx significantly. Separating the solids and liquid stream simplifies the treatment of faecal sludge and septage and helps to optimise the process. Ex. In case of heat drying, dewatering will save a significant amount of energy.

Dewatering can be achieved by gravity settling or filtration. However, it needs to be noticed that dewaterability of faecal sludge is less as compared to septage. Hence, in such cases, stabilisation is recommended before dewatering.

Dewatering can also be achieved by increasing the solid content in the faecal sludge or septage. In case of pyrolysis or incineration, addition of dehydrating agent such as sawdust or wood chips is done to increase the solid content as well as the calorific value of the solids.

It needs to be kept in mind that after dewatering, the liquid fraction might contain high amount of ammonia, salts or pathogens.

## Treatment objectives

### PATHOGEN REMOVAL

- FSS contains large amount of pathogenic micro organisms
- Significant health risk due to direct/in direct exposure
- Treatment up to adequate hygienic level
- Reduction/inactivation
  - Starvation
  - Predation
  - Exclusion
  - Desiccation
  - Temperature

The second most important objective is pathogen removal. Pathogen removal is important from the discharge and reuse point of view of the end products. Faecal sludge and septage is known to contain high amount of pathogens and hence indiscriminate disposal of it may result in cross contamination of the water resources. Reduction of pathogen is achieved by various ways as listed in the slide.

Starvation refers to starving the pathogen to death. Predation refers to introducing or allowing specific types of bacteria to eat (predate) the pathogens. Exclusion refers to physical exclusion of pathogens depending on their size using filters. Desiccation refers to reducing the moisture content to the level where the cell walls rupture due to dryness. Pathogens are believed to reduced significantly at temperatures above 600C.

## Treatment objectives

### NUTRIENT RECOVERY

- FSS contains significant concentrations of nutrients
- Can supplement synthetic fertiliser
  - Nitrogen based fertiliser is recovered from fossil fuel
  - Phosphorus is mined from finite resources such as ores
- If not managed properly can lead to;
  - Eutrophication and algal blooms
  - Contamination of drinking water

Nutrient recovery is a specific treatment objective which is very important when we are intending to use the end products as soil supplements for improving its characteristics. Faecal sludge and septage contain good amount of nutrients. If managed properly, these nutrients can be used as a supplement to synthetic fertilisers in agriculture. However, if not managed properly, it leads to eutrophication of water bodies and further it may lead to contamination of drinking water resources.

## Treatment objectives

### STABILISATION

- FSS has high oxygen demand
- Depletion of oxygen is surface water bodies

#### Indicators of stabilisation

- TVS
- BOD
- COD

Degradable organic matter

biodegradation

Carbon based molecules that are not readily degradable, stable complex molecules (cellulose and lignin)

Stabilisation of faecal sludge is also one treatment objective. Faecal sludge contains more organic solids which needs stabilisation before it can be discharged into the environment. Stabilisation reduced the oxygen demand of the liquid fraction of the faecal sludge. The need of stabilisation can be assessed using parameters such as volatile solids, BOD and COD.

## 2. Approaches for FSSM

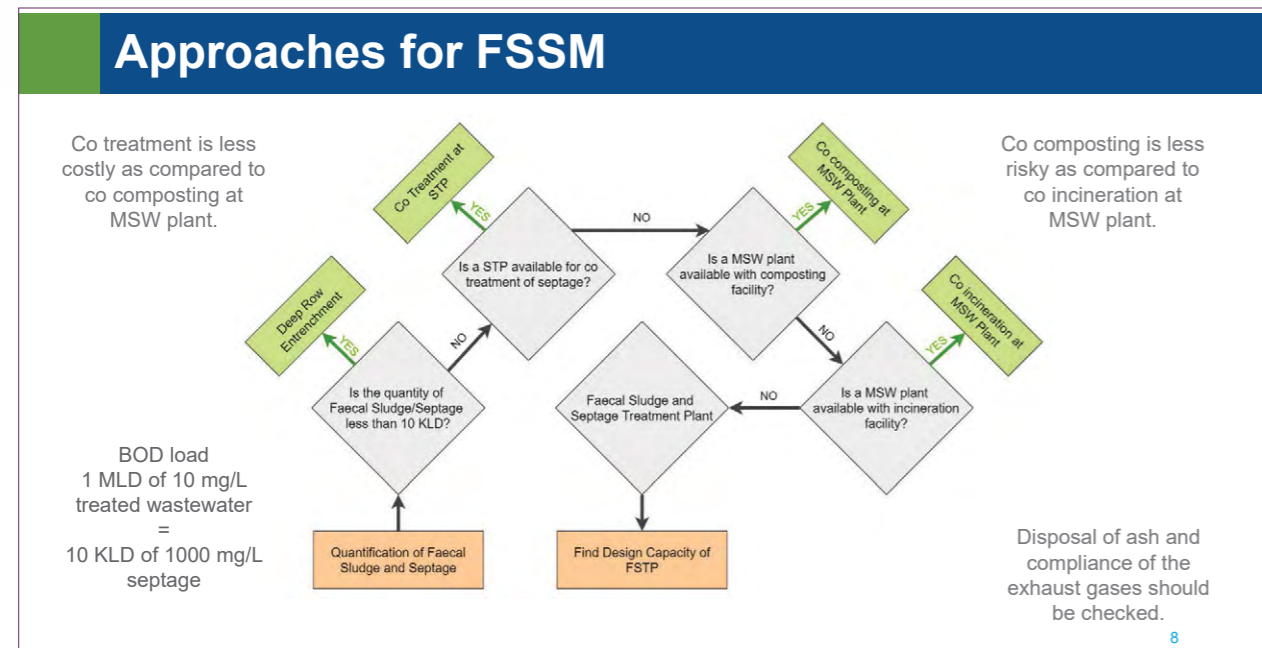

There can be different treatment approaches in FSSM which is dependent on the quantification and characterization of FSS. In the first step, if the quantity of FSS is less than 10 KLD then the Deep Row Entrenchment can be the simple, low cost and less O&M approach in FSSM though the limiting factors has to be considered while site selection. It is recommended that the selected site should be away from water bodies and high groundwater table areas.

In the next approach, if the FSS is above 10 KLD and there is availability of STP in the locality/ULB level then it can be co-treated with Sewage Treatment plant. Usually, co-treatment in STP approach is less costly than the co-composting or separate FSTP. The study has to be carried out for the proper application of FSS at appropriate point at STP (i.e. at manhole chamber before inlet or at screen or at sludge management facility)

If there is no STP with ULB but there is availability of municipal solid waste processing facility with organic waste composting then ULB can select the approach of co-composting of FSS with municipal waste processing facility. In this case, FSS has to be dewatered and solid content has to be in the range of 40-45% while co-composting it with organic waste composting.

In other case, if composting facility is not available but incineration facility is there at municipal waste processing facility then dried FSS can be co-incinerated. But in this case, FSS has to be dewatered and dried and solid content has to be around 80% or more. This is not a feasible option compared to co-composting approach as it demands high energy, maximum human resources, proper compliance for disposal of ash and exhaust gases.

In the last when all above options are not applicable then there is need of specific faecal sludge and septage treatment plant (FSTPs). There are different technologies as mechanized or non-mechanized or hybrid for the FSTPs.

## Deep Row Entrenchment

- Required appropriate plot of land with secured fencing.
- Deep trenches, filled with sludge and covered with soil.
- **Advantages:** Simple, low cost, limited O&M, low visible or odour nuisance.
- **Limiting factor:** Land and groundwater table, legislation.



Deep row entrenchment (DRE) refers to the method where septage is fed to an excavated pit. Once the pit is fed with septage, the liquid seeps into the surrounding soil and the solids are arrested in the pit. Once the pit is full it is topped off with the excavated earth so that the solids can be stabilized. Once stabilized the content of the pit are converted into terra preta, which can be safely used in agriculture to improve the characteristic of the soil.

DRE is very simple and low on operational expenditure. It does not create any visible or olfactory nuisance. ULBs usually have heavy machinery for earth excavation readily available with them and hence, no specialised equipment is required to start practicing DRE. DRE cannot be practiced in low lying areas and region where ground water table is high.

## Co treatment in STP

### Limiting factor

- Organic & hydraulic loading on various treatment units of STP

### Application

- At the Manhole Chamber before the inlet of STP
- At the inlet of Screens of the STP
- At the Sludge Management Process of the STP





## Co treatment in MSW Plant

### Co Composting of Biosolids

- Dewatering of Sludge
- Dry solid content - in the range of 40 - 45%
- Provides nitrogen to the compost

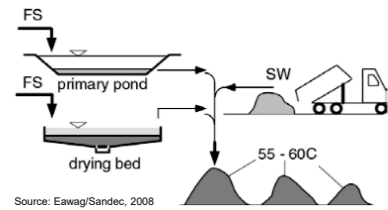

### Incineration of Biosolids

- Dewatering and Drying
- Dry solid content - at least 80% or higher
- Increases heat production

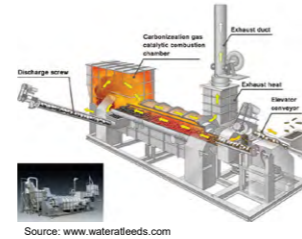

## 3. Selection of Treatment Mechanisms

### Selection of Treatment Units

Treatment performance	Local context	O&M requirements	Costs
-----------------------	---------------	------------------	-------



Prioritizing local context and O&M requirement indirectly takes care of performance and life cycle cost of the project!

## Selection of treatment mechanisms

Treatment performance	Local context	O&M requirements	Costs
<ul style="list-style-type: none"> <li>• Effluent and solids quality according to the discharge / reuse standards</li> </ul>	<ul style="list-style-type: none"> <li>• Characteristics of sludge (dewaterability, solids concentration, stabilisation, spread ability)</li> <li>• Quality of the frequency of the sludge to be received at treatment facility</li> <li>• Climate</li> <li>• Land availability and its cost</li> <li>• Interest in the enduse</li> </ul>	<ul style="list-style-type: none"> <li>• Availability of skilled persons for operation-maintenance and monitoring</li> <li>• Availability of spares locally in case of mechanical equipment.</li> </ul>	<ul style="list-style-type: none"> <li>• Investment costs covered (land acquisition, infrastructure, human resources, capacity building and training)</li> <li>• O&amp;M costs</li> <li>• Affordability for households and ULB</li> </ul>

The selection of the treatment mechanisms depends on various factors listed in the slide above.

### Treatment performance

- Treated wastewater discharge standards by CPCB
- No standards for treated solids by CPCB
  - FCO (2013)
  - US EPA



#### Fertilizer Control Order (2013), India

- City compost
  - Total organic carbon- 12% by weight
  - Total nitrogen- 8% by weight
  - Total phosphates- 0.4% by weight
  - Total potash- 0.4% by weight
  - C:N ratio- <20
  - Pathogens- NILv

#### Standards for Class A Bio-solids of US EPA

- Faecal coliform density < 1000 MPN/gm total dry solids
- Salmonella sp. Density <3MPN/4gm total dry solids
- Helminth egg concentration < 1/gm total dry solids (WHO, 2006)
- E-Coli 1000/gm total solids (WHO,2006)

The primary criteria are that the treatment facility should be able to produce end products meeting the standards of discharge/ enduse. Currently there are standards for the wastewater which have been adopted for the treated liquid fraction for FSTPs. However, there are no standards laid down for biosolids in STPs and FSTPs. Hence, the primer and the National FSSM policy recommend to follow US EPA standard or WHO standards.

## Local context

- **Characteristics of sludge**
  - Degree of stabilisation
  - Dewaterability
  - Concentration
- **Quantity of the sludge**
  - Scheduled desludging
  - Demand desludging
- **Climate**
  - Temperature
  - Humidity
  - Precipitation
- **Land availability**
  - Area
  - Cost



INTEREST IN THE ENDUSE

Most important criteria is the local context. The characteristic of the sludge and its characterisation ratios. The frequency of desludging affects the quality of the sludge. Hence, if the frequency of the desludging is high, there is a possibility of having faecal sludge. In that case, stabilisation of sludge becomes important. Climate plays an important role in case of all-natural treatment mechanisms such as evaporation, evapotranspiration and stabilisation. Land availability and its cost of acquisition must also be considered before finalising the treatment mechanisms. In cases where the land is not available and acquisition of it is costly or time consuming, it is advisable to go for treatment mechanisms demanding less area. If there is interest in the use of end products of treatment, then treatment mechanisms suitable to produce those end products in demand should be chosen. Ex. In cases where there is a demand for biochar, pyrolysis will be suitable treatment mechanisms for pathogen reduction.

## O&M requirements

- **Skills needed**
  - Skill set required for people to operate the treatment system
- **Level of O&M needed**
  - Does the treatment system needs frequent maintenance?
- **Monitoring required**
  - Does the treatment system needs continuous monitoring?
- **Availability of spare parts**
  - In case of break down are the spares available locally?



Availability of resources such as skilled persons, spares etc at local level is very important. In absence of local availability of the resources, no treatment technology is going to economically viable inspite of it producing very high-quality end product.

## Costs

- **Investment costs**
  - Land
  - Infrastructure and electromechanical components
  - Establishment cost
  - Capacity building
- **O&M Cost**
  - Human resource
  - Energy
  - Consumables



**AFFORDABILITY to the household**

This is critical for sustainability of the faecal sludge management system

The CapEx and OpEx of technology is also one of the criteria, although not the only criteria. Affordability of the complete project to the ULB or the end beneficiaries such as households should also be checked.

## Summary

- Treatment objectives and their importance
- Dewatering is important objective and helps to optimise the treatment system
- Characteristics and quantity of the FSS needs to be determined
- Other local context can also be deciding factors for selection of treatment mechanisms
- The end product and its disposal/reuse needs to be assessed

Session

**08**

# **Formation of Faecal Sludge & Septage Treatment Technologies**

---

## Learning objectives

In this session we will be understanding how to form treatment chain for faecal sludge and septage.

We will look deeper into natural treatment units for treatment of faecal sludge and septage.

## Contents

- Stages and mechanisms of FSS treatment
- Natural FSS Treatment units
  - Settling thickening tank
  - Anaerobic digestion
  - Unplanted drying beds
  - Planted drying beds
  - Co composting
- Case studies

### 1. Stages & Mechanisms of FSS Treatment

## Treatment chain FSS

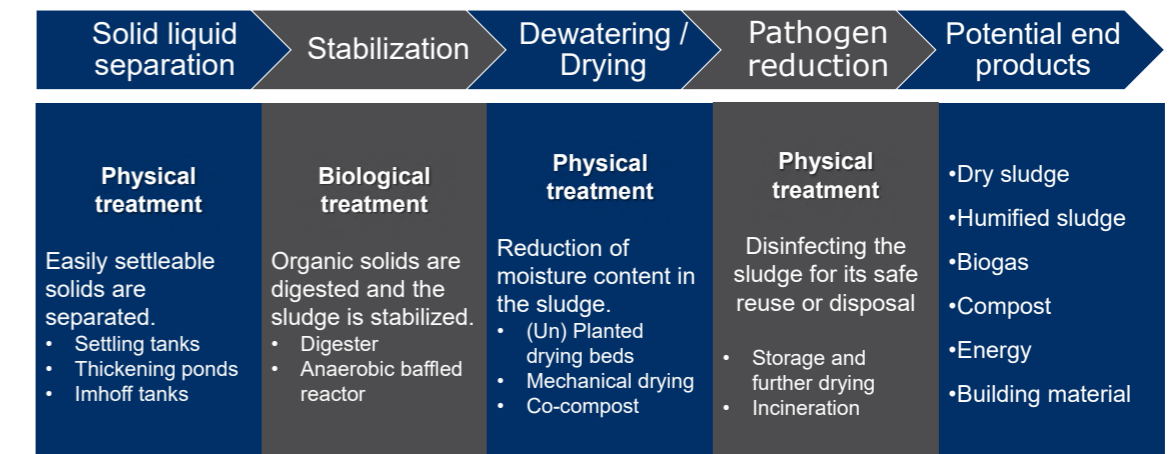

Treatment facilities are a combination of different treatment mechanisms. Each treatment mechanisms have a specific treatment objective. Faecal sludge and septage treatment plants can be divided into four stages. At least three stages are put together to achieve complete treatment of faecal sludge and septage. Pre-treatment of septage such as screening is always recommended before starting with actual treatment processes.

Solid liquid separation- This stage refers to separation of easily settleable solids. Septage is known to have a higher content of non-biodegradable particulate COD. This COD can be reduced

significantly by separating the solids from the liquid fraction. Solid liquid separation is based on physical treatment and can be achieved by settling thickening tanks or geo tubes.

**Stabilisation-** This stage refers to the stabilisation of organic solids in the sludge. Faecal sludge is known to have higher content of slowly biodegradable COD. Reduction of COD in such cases can be achieved using biological treatment in the form of anaerobic treatment. Anaerobic digestion provides stabilisation of the difficult to digest solids. The process reduced the odour and increases the dewaterability of the sludge.

**Dewatering/ Drying-** This stage refers to reduction of water content in the sludge. This can be achieved by treatment mechanisms such as evaporation, evapotranspiration, heat application. Treatment units such as planted, unplanted drying beds or mechanical dewatering equipment is suitable to achieve adequate reduction in the water content.

**Pathogen reduction-** This stage refers to reduction in the pathogens in the sludge. The same can be achieved by various ways, however, the most common way is to store the solids for longer duration (starvation) or to expose the solids to temperatures up to 700C or application of heat to drive away the moisture (desiccation).

Depending upon the treatment units selected for forming the treatment chain, end products such as dry sludge, humified sludge, biogas, energy etc is produced.

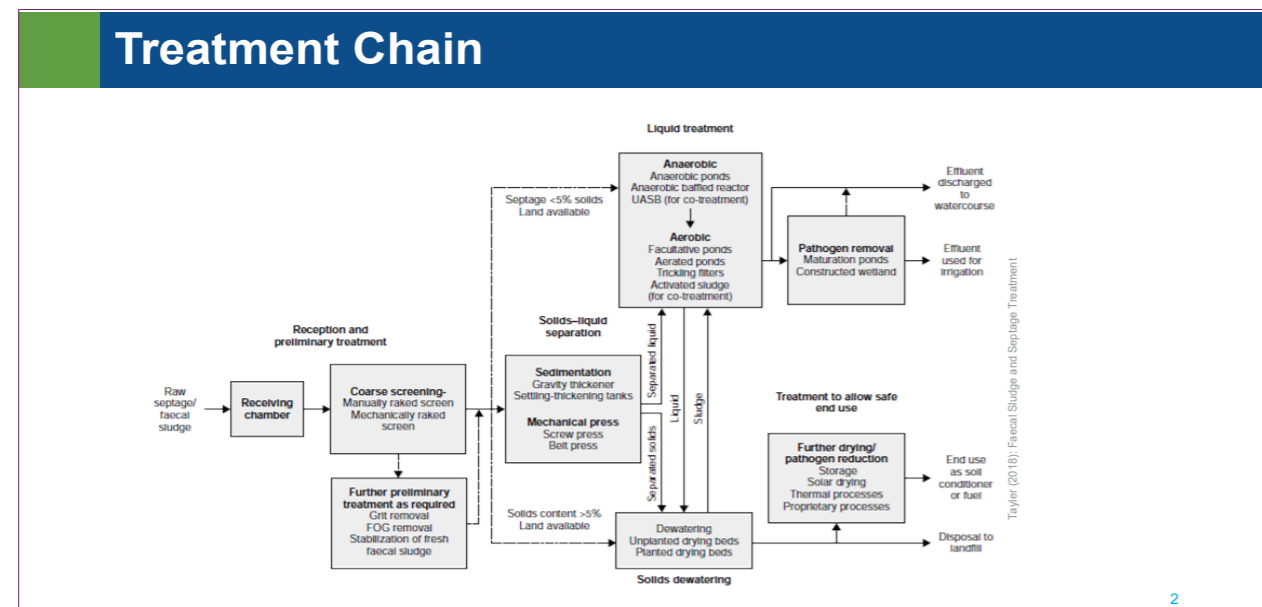

## 2. Natural FSS Treatment Units

### Settling Thickening Tank

- Most commonly employed method.
- Based on specific gravity of the particles, suspended solids concentration and flocculation.
- Settling mechanisms
  - Discrete particle
  - Flocculent
  - Hindered
  - Compression

The diagram shows a cross-section of a settling thickening tank. It has a conical bottom. 'Septage discharged by tankers' enters from the left through a 'Screen'. 'Pipe connections' are at the top. The 'Top water level controlled by penstock' is indicated. The tank contains 'Supernatant' (liquid) and 'Sludge' (solids). At the bottom, there is a 'Filter bed sand above gravel' and an 'Underdrain system'. 'Penstock' is also labeled on the right side. The outlet on the right is labeled 'To anaerobic pond'. A small text at the bottom right reads 'Taylor (2018): Faecal Sludge and Septage Treatment'.

Settling thickening tanks are the simplest kind of treatment unit. It is the most commonly used treatment unit for solid liquid separation in case of faecal sludge and septage treatment. The separation takes place due to difference in the specific gravity of the solids and their masses. The fat – oil – grease which has lower specific gravity tends to float up to the surface of the water. Hence, in the settling thickening tank, the incoming sludge is given appropriate hydraulic retention time, where in the solids and the fog separate and the liquid effluent comes out from the outlet. The settled sludge then undergoes compaction due to hydraulic pressure from the top, resulting into thick dense layer suitable for pumping. When designed and operated well, the settling thickening tanks can result solids concentration from 1% to up to 12% in the thickened sludge.

### Anaerobic digester

- **Organic matter**  
Biogas (methane and CO<sub>2</sub>) and digestate.
- **Advantages**  
Production of biogas, reduction of sludge volume and odours.
- **Limiting factor**  
High level of skilled operation and monitoring.

The diagram shows a 'Fixed Dome Anaerobic Digester'. 'Screened faecal septage in' enters from the top. 'Gas draw-off as required' is shown at the top. 'Gas' is produced and 'Gas pressure depresses water level'. 'Sludge draw-off pipe - typically 200 mm dia.' is shown at the bottom. 'Sludge' is at the bottom. 'Periodic sludge draw-off under hydrostatic pressure' is shown on the left. 'Biodigester effluent' is shown on the right. A 'TWL' (water level) is indicated. A small text at the bottom right reads 'Taylor (2018): Faecal Sludge and Septage Treatment'.

Anaerobic digester is used for stabilisation of solid in faecal sludge. Faecal sludge has higher content of slowly biodegradable COD. Hence to stabilise these solid and bring down the COD, anaerobic digester with retention time of 20-30 days is designed. The advantage of anaerobic digester is that it produces methane gas which can be used for generating energy. Digestion also results in reduction in sludge volume and odour. It increases the dewaterability of the sludge. The limiting factors for implementation in anaerobic digester is that it requires monitoring on a daily basis and skilled persons for operating the treatment unit.

## Unplanted drying beds

- Shallow filters with sand and gravels with under drain to collect filtrate.
- **Application:** Climatic factor and types of sludge
- **Advantages:** Low cost and ease of operation.
- **Limitation:** Large footprint and odour potential

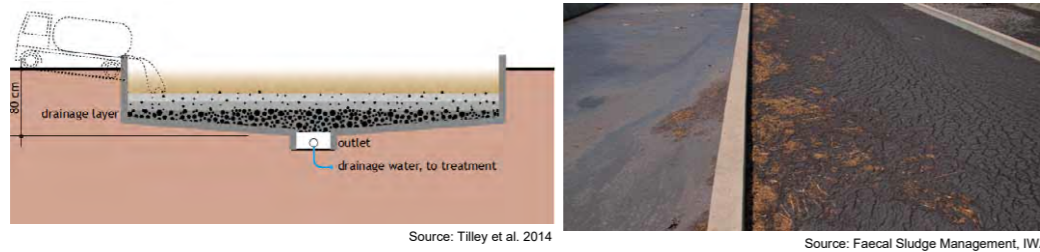

Source: Tilley et al. 2014

Source: Faecal Sludge Management, IWA

Unplanted drying beds are shallow filters with filter bed made out of combination of gravel and sand. The beds have under drain to collect the filtrate which is collected in filtrate sump by gravity. The free water in the sludge drains out of the filter bed and the bound water is removed from the sludge by evaporation. The design of the sludge drying bed is based on the evaporation rate which is determined by the average temperature and humidity. The operational cycle of unplanted sludge drying beds ranges into weeks depending upon the local conditions. The sludge drying beds have relatively low CAPEX and since they are easy to operate and low on OPEX. The biggest limitation of drying beds is their area requirement is quite high and if not operated properly the odour can be a nuisance.

## Planted drying beds

- Unplanted drying bed with emergent macrophyte.
- **Application:** Climatic factor
- **Advantages:** Low cost and ease of operation.
- **Limitation:** Large footprint and odour potential

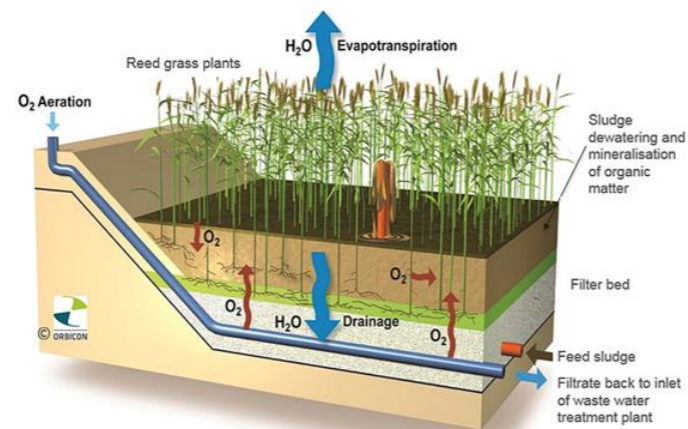

Planted drying beds are similar to the unplanted drying beds having macrophytes such as cattail, typha etc. In this case the bound water is removed by evapotranspiration. The difference between the planted drying bed and unplanted drying bed is the way they are operated and stabilization of sludge. Unlike unplanted drying beds, the operational cycle of planted drying beds is in months. Each bed is used for months before it is made non-operational. Since the sludge stays in the beds for a long time, mineralisation of the sludge also occurs. The nutrients are taken up by the plants leaving behind mineralised solids behind.

In most of the cases the planted drying beds are made dysfunctional, however there are cases where the filter media has been removed, washed and reinstalled. The application criteria, advantages and limitations are similar to unplanted drying beds.

## Co composting

- C:N Ratio = 20-30:1, Oxygen concentration: 40-60%, Particle diameter < 5 cm
- **Advantages:** Thermophilic condition- Pathogen inactivation
- **Limiting factors:** Technical and managerial skills

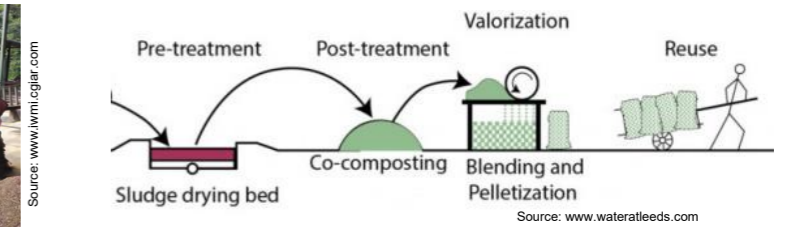

Co composting can be performed on the dewatered sludge. Sludge is rich in nitrogen and if mixed with organic solid waste to achieve C:N ratio of 30 then aerobic composting can be achieved. Thermophilic condition is required for pathogen inactivation and hence care needs to be taken to achieve optimum temperature and maintain oxygen concentration between 40% - 60%. The advantage of the co composting is that it performs drying and pathogen reduction simultaneously and generates an end product with higher value in the market. Limiting factors to practice co composting can be technical and managerial skills along with area required to manage the piles.

## Sludge incineration

- Burning of sludge at temperature 850-900°C
- **Advantages:** Volume and pathogen reduction.
- **Limiting factors:** emission of pollutants, high skilled operator and maintenance staff, high capital and O& cost

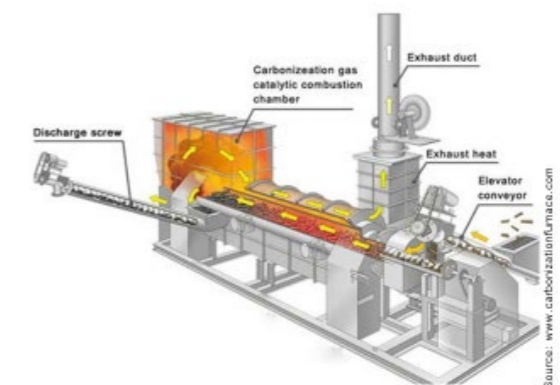

The dewatered sludge is dried using the hot air from the combustion chamber. The dried solids then fall into the combustion chamber. This chamber can be operated as an incinerator or pyrolyzer. The operating temperature and supply of oxygen determines of the combustion process. The solids are first converted into carbon (commonly known as biochar) at a lower temperature (400 C – 600 C) and further the biochar burns to produce more heat and higher temperature up to 8000 C – 9000 C.

There is complete elimination of pathogen from the solids and significant volume reduction is also achieved. The advantage of such a system is that it is very compact and gives quite consistent results. The end product such as biochar has good calorific value and can be used in furnaces. However, economic viability needs to be checked. Disadvantages are the high CAPEX, need of electricity to for treatment and requirement of skilled persons makes it costly and difficult to operate.

## Sludge storage yard

- Easy access for motorised vehicles for hauling of bio solids
- Adequate area to store dried solids for couple of weeks.
- Ventilated and covered with access to sunlight
- Partitions for batches of bio solids



Sludge storage yards are used to store the sludge for a few weeks before it can be sent for disposal or reuse. It should have access via road with minimum width of 3.5 m. This eases the access and hauling of biosolids for use/discharge outside the plant. Adequate area should be planned so that the solids can be stored for a couple of weeks. Sludge storage yards should be well ventilated and should have transparent covers so as to allow sunlight to pass through it.

## Elimination baseda approach

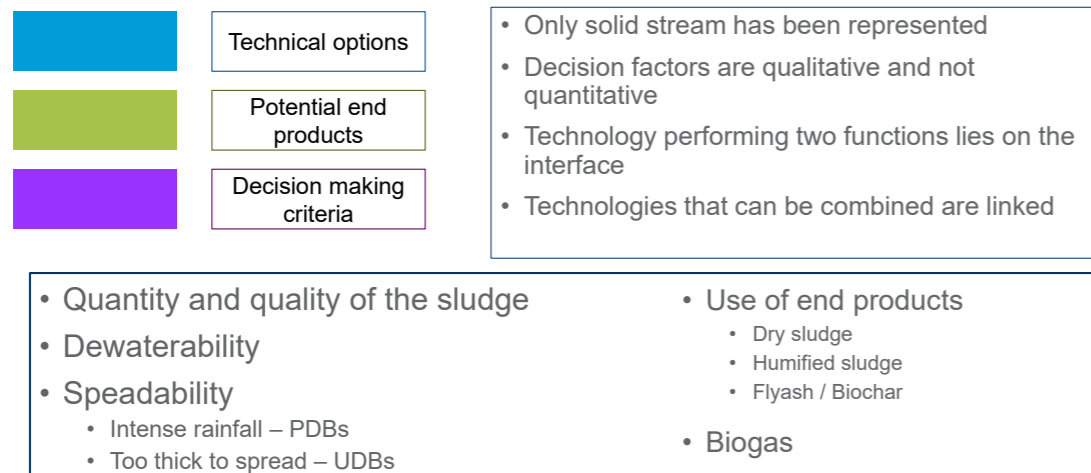

This slide describes the approach for selecting a context appropriate combination of faecal sludge and septage treatment technologies.

## 3. Case Studies

The city of Bhubaneswar is planning for sewerage sanitation system, however, until the sewerage network and STP is developed, Odisha Water Supply and Sewerage board installed a SeTP with design capacity of 75 KLD. The treatment chain is elaborated in the slide above. The plant treats the solids and liquid completely and has been designed as a zero liquid discharge plant. The biosolids are reused for plantation around the plant and the liquid is also completely utilised in and around the plant to maintain the green spaces.

After the receiving ramp, the septage is emptied into the screen chamber, which segregates the solid waste from the septage. The septage then flows into the STT where the solid liquid separation happens and the sludge undergoes thickening process. The thickened sludge is then pumped to the sludge drying beds for further dewatering and drying. The dried solids are then co composted with the organic waste (dry waste from the lawn and plants in the SeTP premise). The liquid from the STT flows under gravity to the anaerobic treatment (anaerobic settler, anaerobic baffled reactor and anaerobic upflow filter) followed by aerobic treatment in constructed wetlands. Finally, the clarified water comes to polishing pond where is disinfected and kept aerated using cascade aeration.

## Septage Treatment Plant- Bhubaneshwar



Source: Dhawal Patil, ESF

## Septage Treatment Plant- Rudrapur

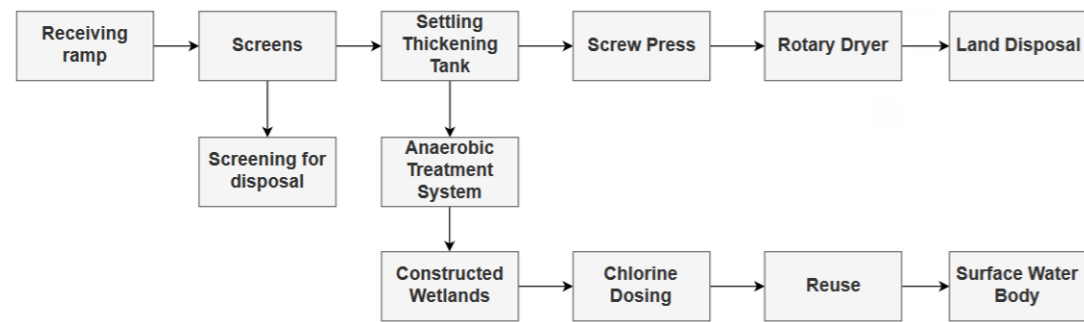

In case of Rudrapur, similar treatment scheme is used for liquid effluent from STT. However, the thickened sludge is sent for mechanical dewatering using screw press followed by rotary dryer which ensures complete disinfection of biosolids. Due to the proximity of the plant to the residential premise and relatively cooler climatic conditions, unplanted sludge drying beds were avoided. The design capacity of Faecal sludge and Septage Treatment plant is 125 KLD. The treatment chain is shown in the slide above. The biosolids will be sent for land disposal and the treated water will be sent for disposal in the surface water body next to the treatment plant.

## FSS Treatment Plant- Port Blair

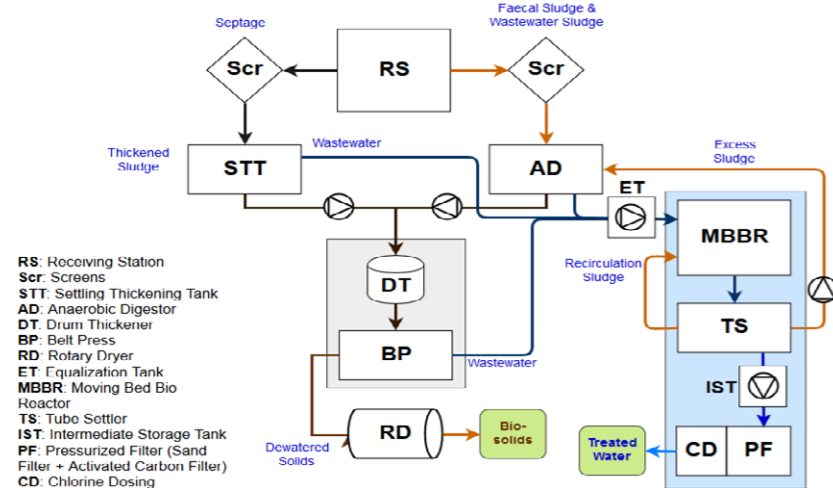

## Septage Treatment Plant- Bhubaneshwar

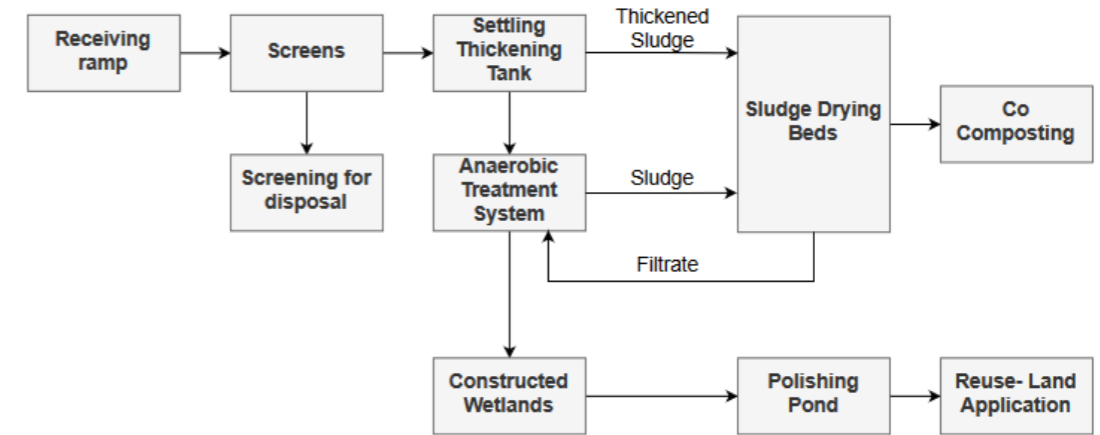

The city of Puri has sewerage sanitation system and had planned for STP with design capacity of 15 MLD based on aerated lagoon technology. However, due to technical difficulties not all the properties can be connected to the sewerage network and hence co treatment of septage was adopted for completing the non sewerage system. Currently the co treatment facility is located at the STP and has been augmented with screens and settling thickening tank (STT) of capacity 50 KLD. The liquid effluent from the STT goes for treatment into the waste stabilization pond system where as the thickened sludge is sent for drying to sludge drying beds which were planned for STP. The treatment chain for co treatment of septage has been elaborated in the slide above.

## Co Treatment- Puri





## Summary

- FSS treatment facility consist of up to four stages, each having specific treatment objective.
- FSS treatment facility consists of multiple components to achieve the desired treatment objectives.
- Defining the right treatment objective is the key to selection of appropriate treatment components for FSS treatment facility.

Session

**09**

# Designing of Solid Liquid separation Unit: Settling Thickening Tank

---

# Contents

## Settling – Thickening Tanks

- Concept
- Designing
- Operation & Maintenance

### 1. Concept

#### Concept

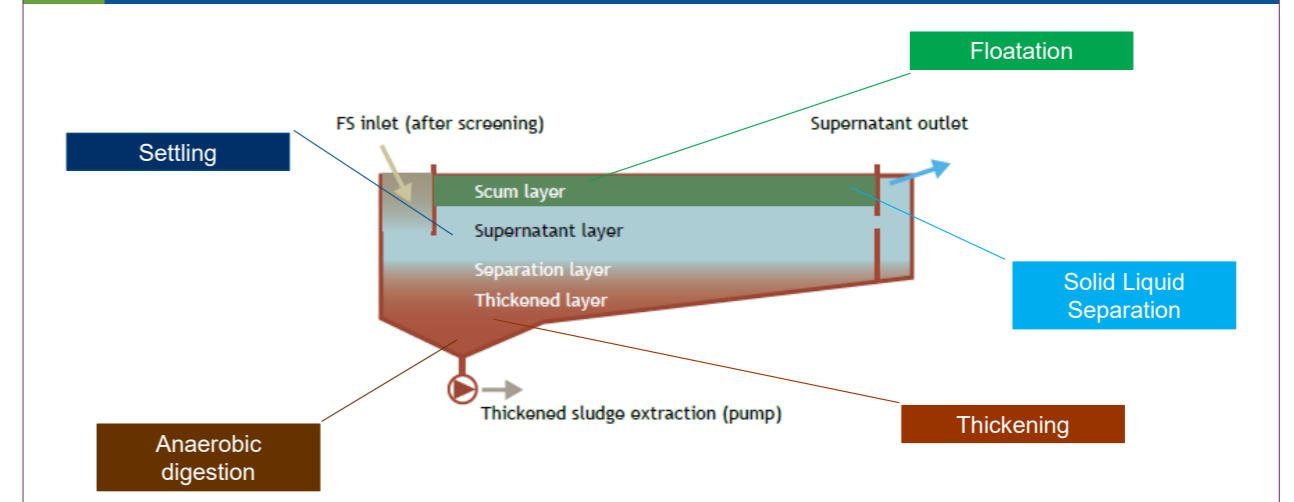

### 2. Designing

#### Designing

- Sludge Volume Index: volume of settled sludge per gram of solids.
- Imhoff cone, settling for 30-60 min, ml/L
- SS concentration: g/L
- $SVI = \text{Volume of settled sludge} / \text{SS concentration (ml/g SS)}$

SS concentration = 6.6 g/L; Volume of settled 198 ml/L  
SVI = ?

SVI less than 100 ml/g SS achieves good solids-liquid separation in settling and thickening tanks. Settling happened rapidly in the first 30 min and then thickening can continue for up to 100 minutes.

## Designing Part I

### Tank surface area

$$Q_p = (Q \times C_p) \div h$$

Where:

$Q_p$ = influent peak flow

$Q$ = mean daily influent flow

$C_p$ = peak coefficient

$h$ = number of operating hours of the treatment plant

$$S = Q_p \div V_u$$

Where:

$S$ = surface area of the tank ( $m^2$ )

$Q_p$ = influent peak flow ( $m^3/h$ )

$V_u$ = upflow velocity ( $m/h$ )  $\sim 0.5 m/h$

### Tank length

Width to length ratio= 1:10 – 1:5

Scum zone= 0.4 m (with one week loading, one-week compaction and cleaning) 0.8 (with four weeks loading, four weeks of compaction and cleaning)

### 3. Operation & Maintenance

## Operation and Maintenance

#### • Start up period

- Adjust load time
- Asses the depths of zones
- Optimise the compaction time
- Sludge removal frequency

#### • Seasonal variation

High temperature results into higher solid concentration in scum and increase in rate of digestion.

#### • Sludge removal

- Pumps
- Shovels

#### • Scum removal

- Scrapper
- Manual

Session

10

# Designing of Stabilization Unit: Anaerobic Digester

# Contents

## Anaerobic digester

- Concept
- Design parameters
- Designing
- Operation and maintenance

### 1. Concept

#### Concept

##### Important parameters in digestion

- Temperature
- Time of digestion
- Correct feeding (no inhibitor)
- Proper seeding and mixing

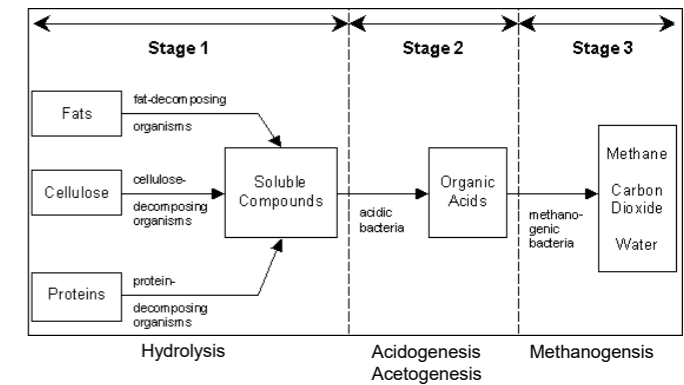

Psychrophilic  
7°C – 20°C | 12 – 25 weeks

Mesophilic  
20°C – 40°C | 20 – 30 days

Thermophilic  
40°C – 65°C | 3 – 5 days

#### Zones in digester

- Mixing zone: Incoming sludge is mixed with the stabilised sludge.
- Sludge zone: Stabilisation of the sludge takes place here.
- Liquid zone: Liquid separates from the stabilised solids.
- $V_g, V_{sc}, V_l, V_{sl}$

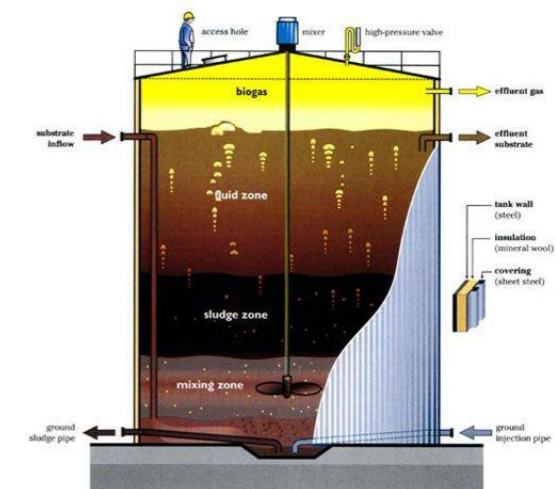

## 2. Design Parameters

### Design parameters

- Temperature of the reactor
  - Determines the reaction rate
  - Generation of biogas
- Hydraulic retention time
  - Solid settling
- BOD<sub>removal</sub>
  - Sludge generation
- COD<sub>removal</sub>
  - Biogas generation

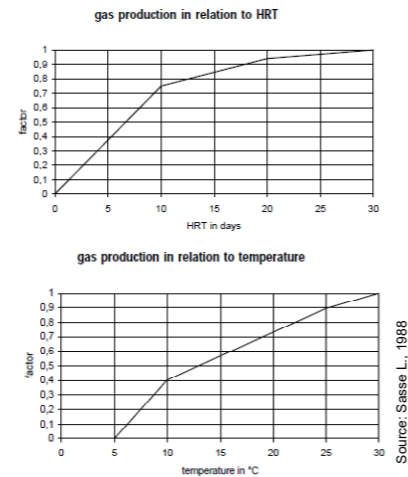

## 3. Designing

### Designing I

#### COD removal rate

$$= \frac{\text{Settleable Solids}}{\text{COD}} \text{ ratio} \times f_{\text{HRT}}$$

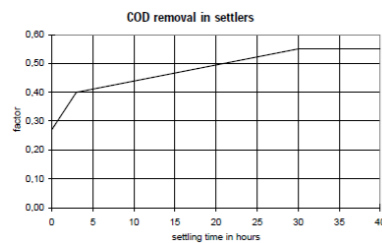

#### BOD removal rate

$$= \text{COD removal rate} \times f_{\text{COD/BOD ratio}}$$

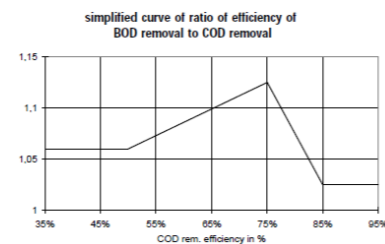

### Designing II

#### Effluent COD (COD<sub>out</sub>)

$$\text{COD}_{\text{out}} = \text{COD}_{\text{in}} \times (1 - \text{COD}_{\text{re. rate}})$$

Similarly,  
calculate BOD<sub>out</sub>

#### BOD<sub>removed</sub> in desludging frequency

$$\text{BOD}_{\text{removed}} (\text{gm}) = (\text{BOD}_{\text{in}} - \text{BOD}_{\text{out}}) \times Q \times 30 \times N$$

Where;  
Q= daily influent flow (m<sup>3</sup>/d)  
N= desludging frequency (months)

Similarly,  
calculate COD<sub>removed</sub>

### Designing III

#### Sludge Volume

$$V_{\text{sl}} (\text{m}^3) = \text{Specific Sludge Production} \times \text{BOD removed}$$

Where;

V<sub>sl</sub>= Accumulated sludge volume (m<sup>3</sup>)  
Specific sludge production= 0.0045 L per gm BOD removed (ranges between 0.0035 ~ 0.005 L per gm BOD removed)

#### Liquid volume

$$V_l (\text{m}^3) = Q \times \text{HRT}$$

Where;

V<sub>l</sub>= Volume of liquid to be retained (m<sup>3</sup>)  
Q= daily influent flow (m<sup>3</sup>/d)  
HRT= Hydraulic retention time 30 hours (ranges between 24 hr ~ 36 hr)

### Designing IV

#### Scum Volume

$$V_{\text{sc}} (\text{m}^3) = 20\% \times V_l$$

Where;

V<sub>sc</sub>= Accumulated scum volume (m<sup>3</sup>)  
V<sub>l</sub>= Volume of liquid to be retained (m<sup>3</sup>)

#### Biogas Volume

$$V_g (\text{m}^3) = S_f \times \text{Biogas Yield} \times \text{COD}_{\text{removed}}$$

Where;

V<sub>g</sub>= Accumulated gas volume (m<sup>3</sup>)  
S<sub>f</sub>= safety factor 25%  
Biogas yield= 0.35 L per gm COD<sub>removed</sub>

## Designing V

### Volume of Digester

$$V_{ad} \text{ (m}^3\text{)} = V_g + V_{sc} + V_l + V_{sl}$$

Where;

$V_{ad}$  = Volume of anaerobic digester (m<sup>3</sup>)

### Dimensioning

Height of layers;

Choose from the table provided.

aprox. volume (m <sup>3</sup> )	digester			floating drum		
	inner dia. (m)	outer dia. (m)	height (m)	volume (m <sup>3</sup> )	height (m)	
1.8 / 2.2 / 2.5	1.20	1.66	1.64 / 1.95 / 2.27	0.5	1.05	0.60
2.6 / 3.6 / 4.6	1.35	1.81	1.87 / 2.57 / 3.27	1.2	1.25	1.00
4.0 / 5.5 / 7.5	1.60	2.08	2.02 / 2.77 / 3.77	1.7	1.50	1.00
5.7 / 7.8 / 10.8	1.80	2.26	2.27 / 3.07 / 4.27	2.1	1.65	1.00
8.6 / 11.6 / 16.2	2.20	2.66	2.27 / 3.07 / 4.27	3.1	2.00	1.00
10.9 / 15.6 / 21.5	2.40	2.88	2.42 / 3.47 / 4.77	4.9	2.25	1.25
14.3 / 20.6 / 28.3	2.75	3.21	2.42 / 3.47 / 4.77	6.6	2.60	1.25
29.4 / 38.3	3.20	3.90	3.66 / 4.77	8.9	3.00	1.25
37.2 / 53.6	3.60	4.40	3.66 / 5.27	11.3	3.40	1.25
41.5 / 65.4	3.80	4.60	3.66 / 5.77	12.7	3.60	1.25
58.5 / 83.8	4.55	5.45	3.66 / 5.77	19.0	4.40	1.25
76.2 / 100.1	5.15	6.05	3.66 / 5.77	23.0	4.85	1.25
101.7 / 160.4	5.95	6.85	3.66 / 5.77	32.4	5.75	1.25
140.9 / 222.0	7.00	7.90	3.66 / 5.77	45.3	6.90	1.25

$$\text{Diameter} = \sqrt{(V_{ad} / 3.14 \times H)}$$

## Optimising the design

- Heating the reactor to 30°C.
- Having homogenous mixing of sludge.
- Having conical bottom helps to increase the sludge height.
- Egg shaped reactor.



Session

11

# Designing of Dewatering Unit: Unplanted Drying Bed

## 4. Operation & Maintenance

### Operation and maintenance

- Maintaining the pH of the reactor.
- Maintaining the temperature of the reactor.
- Maintaining the moisture content.
- Periodic desludging.
- Removal of gas from the reactor.

# Contents

## Unplanted drying beds

- Concept
- Design parameters
- Construction
- Design
- Operation & Maintenance

### 1. Concept

#### Concept

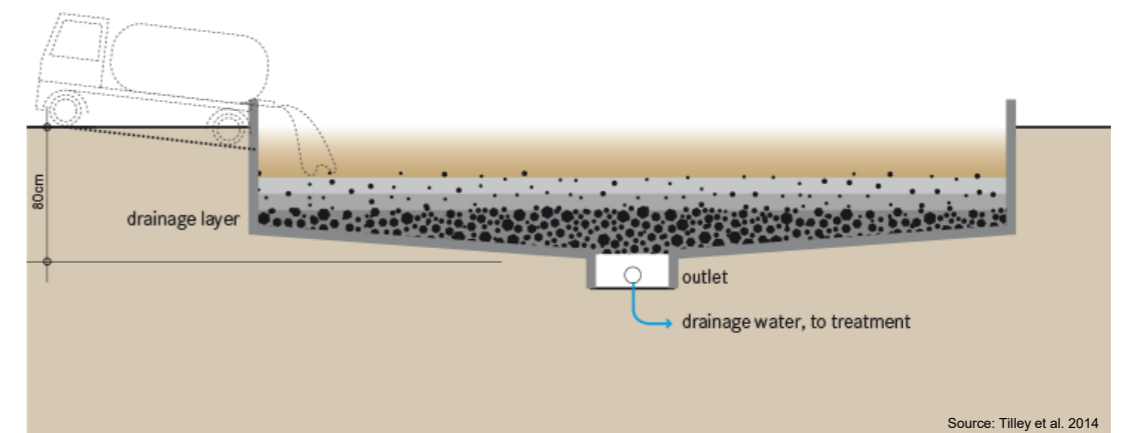

### 2. Design Parameters

#### Design parameters

- **Climate factors**
  - Humidity
  - Temperature and wind
  - Rainfall
- **Type of faecal sludge**
  - Specific sludge resistance for dewatering
- **Sludge loading rate**
  - 100-200 kg TS/m<sup>2</sup>/year
- **Thickness of the sludge layer**
  - 20-30 cm
- **Number of beds**
  - Depends on the area and SLR.

Poor conditions entail high humidity, low temperature, long periods of rainfall, and/or a large proportion of fresh FS. Optimal conditions comprise a low humidity, high temperature, a low amount of precipitation, and stabilised sludge.

A SLR of 300 kg TS/m<sup>2</sup>/year to be effective for dewatering thickened FS with 60 g TS/L, while about 150 kg TS/m<sup>2</sup>/year was estimated to be an effective rate for a FS with 5 g TS/L in the same climatic conditions.

For any particular sludge dried under the same weather conditions, found that an increase in the sludge layer of only 10 cm prolonged the necessary drying time by 50 to 100%. If a layer of 20 cm is applied with a water content of 90%, the initial height before the water is drained-off will be much greater than 20 cm.

### 3. Construction

## Construction

- **Gravel and sand**
  - Drainage layer: 20-40 mm gravels. Height: 15-20 cm
  - Intermediate layer: 5-15 mm. Height: 10-15 cm
  - Sand layer: up to 10 mm. Height: 10 cm
- **Sludge removal**
  - Dry enough that it can be shovelled.
  - Ramp must be provided for wheel barrows or mechanical equipment.
  - Dried sludge should be stored in a dry place.

### 4. Design

## Design

### Sludge loading

$$M = c_i \times Q \times t$$

Where;  
 M= Sludge load in kg TS/year  
 c<sub>i</sub>= concentration of FS in g TS/L  
 Q= flow in m<sup>3</sup>/day  
 t= no. of delivery days per year

### Total area required

$$A = \frac{M}{SLR}$$

Where;  
 A= Total area required for drying beds in m<sup>2</sup>  
 SLR= Sludge loading rate in kg TS/m<sup>2</sup>/year

## Design

### Required drying bed area

$$a = \frac{Q}{SLH}$$

Where;  
 a= area of one drying bed in m<sup>2</sup>  
 SLH= Sludge loading height in m

### Number of beds required

$$N = \frac{A}{a}$$

Where;  
 N= number of beds required

## Height of layers & specifications

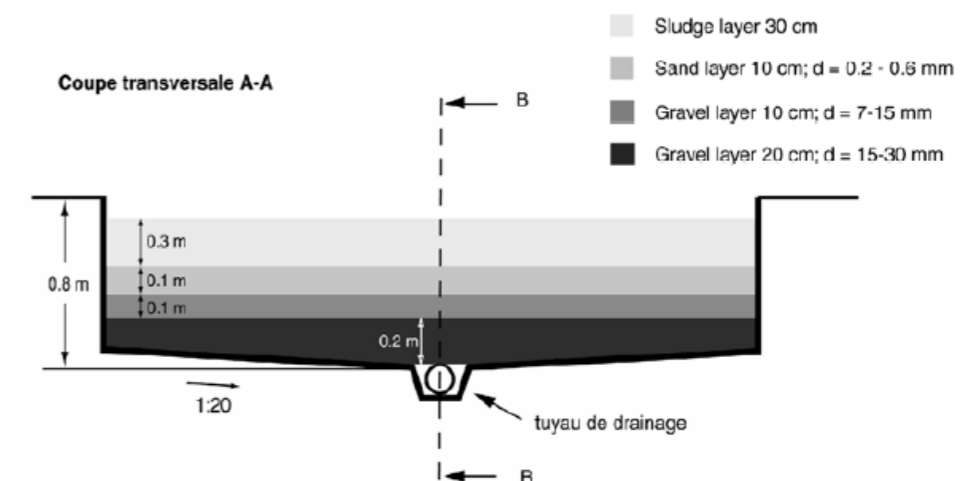

### 5. Operation & Maintenance

## Operation and maintenance

- Pre-treatment of sludge before application.
- Maintaining the sludge loading rate and
- Maintaining the sludge loading height.
- Replacing the layer of sand after few cycles.
- Avoid rewetting of the dried sludge.



Session

**12**

# **Faecal Sludge & Septage Receiving Station**

---

## Learning objectives

In this session we are introducing you to septage receiving stations which are necessary for safe transfer of septage from the vehicle to the treatment facility.

We will also introduce you to the mechanised receiving stations which are necessary at STPs for co treatment of septage and sewage.

## Contents

- Receiving station
  - Dumping stations
  - Screening
  - Grit removal
  - Odour control unit
- Types of receiving station
  - Pre treatment at the headworks of the STP
  - Pre treatment before equalisation
  - Pre treatment after equalisation

### 1. Receiving Station

## Receiving station

### Objectives

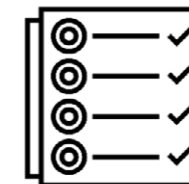

- Safe and easy transfer of septage
- Prevent clogging/fouling and excessive wear and tear of plant equipment
- Storage and equalisation of septage flows
- Prevent fouling of biological treatment process due to inert material

The aim of the receiving station is to reduce the impact and risk on the STP due to co treatment of septage and sewage. The objectives of the receiving station therefore are; (1) it should enable safe and hygienic transfer of septage from hauler truck to the STP, (2) preventive measure to keep a check on O&M cost of the STP, (3) storage and controlled discharge (addition) of septage into the sewage and (4) reduce impact on the secondary stage of the liquid and solid treatment chain at the STP.

## Receiving station

### Design



- Amount of septage to be received
- Design of the desludging truck
- Type of pre-treatment required
- Disposal of solid waste and grit
- Odour considerations

While designing a receiving station, one must consider the following;

1. The quantity of the septage to be received daily along with the number of the trucks to be simultaneously emptied.
2. The design and dimension of the desludging truck, especially the turning radius, its power to operate in reverse mode.
3. Degree of pre-treatment to be given to the raw septage. This depends on the appurtenances and the STP where the mixed septage and sewage will be co treated.
4. Disposal mechanism of the solid waste and grit separated from the raw septage
5. Odour nuisance. If the receiving station is near the residential/commercial area, odour control measures needs to be provided at the receiving station.

## Receiving station

### Components

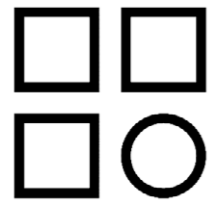

- Dumping station
- Screening
- Grit removal
- Storage / equalisation
- Odour control

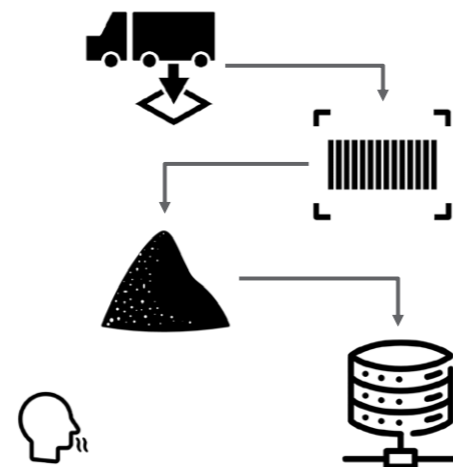

A receiving station consists of one or more of the following components;

1. Dumping station- it enables safe transfer of the raw septage from hauler truck to the pre-treatment components such as screens. It is important that dumping station provides a leak proof equipment for transfer of raw septage and avoid odour nuisance.
2. Screening- this is to eliminate the solid waste such as stones, plastic bags and rags etc which are usually flushed down the toilet or dumped in the septic tanks.
3. Grit removal- Grit removal is an option. However, it is highly recommended to have it so that inert grit along with the fat and grease can be removed from the septage. Both these

constituents have a potential to upset the biological treatment processes at the STP.

4. Storage and equalisation- Storage and equalisation is optional but highly recommended in case of STPs which are utilised for more than 50% of their design capacity. This allows controlled addition of pre-treated septage to the liquid stream depending on the actual flow rate of domestic sewage. In certain cases, storage can also provide necessary solid liquid separation where the supernatant is pumped to the liquid stream while the settled sludge is pumped to the sludge stream of the STP.
5. Odour control- In cases where multiple dumping stations are provided and storage unit does not have aeration unit, odour might be generated. Therefore, an odour control unit needs to be placed. Odour control can be done using chemical scrubbers or activated charcoal filters.

## 2. Dumping station

### Layout of dumping station

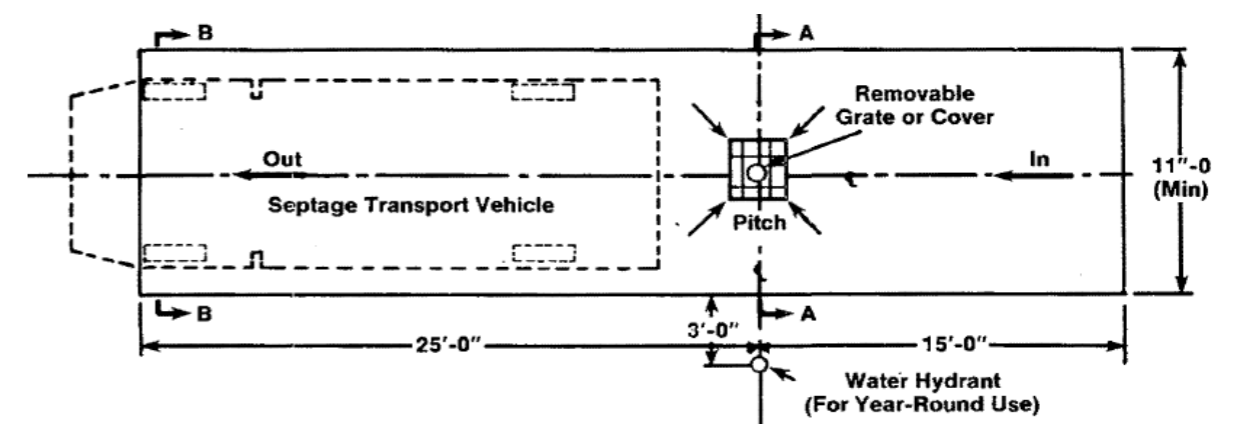

Dumping station has the following components such as (1) Ramp for the truck to enter and exit, the ramp should be sloping towards the dumping inlet so that any spillage or wash water will drain into the dumping hole, (2) Dumping inlet arrangements with a removable lid, (3) Water hydrant with pressurised water hose to wash down any spillage or the truck components after dumping.

### Layout of dumping station

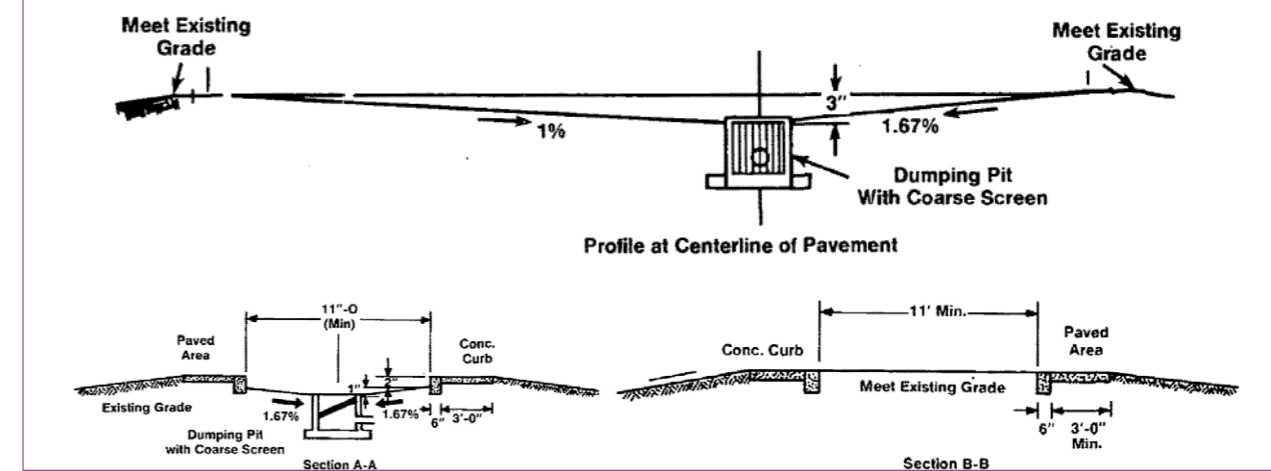

Sections of the dumping station are provided in the diagram above. It should be noted that high grade concrete (M 30 and above) should be used with adequate reinforcement since heavy vehicles would be plying on the ramp from time to time.

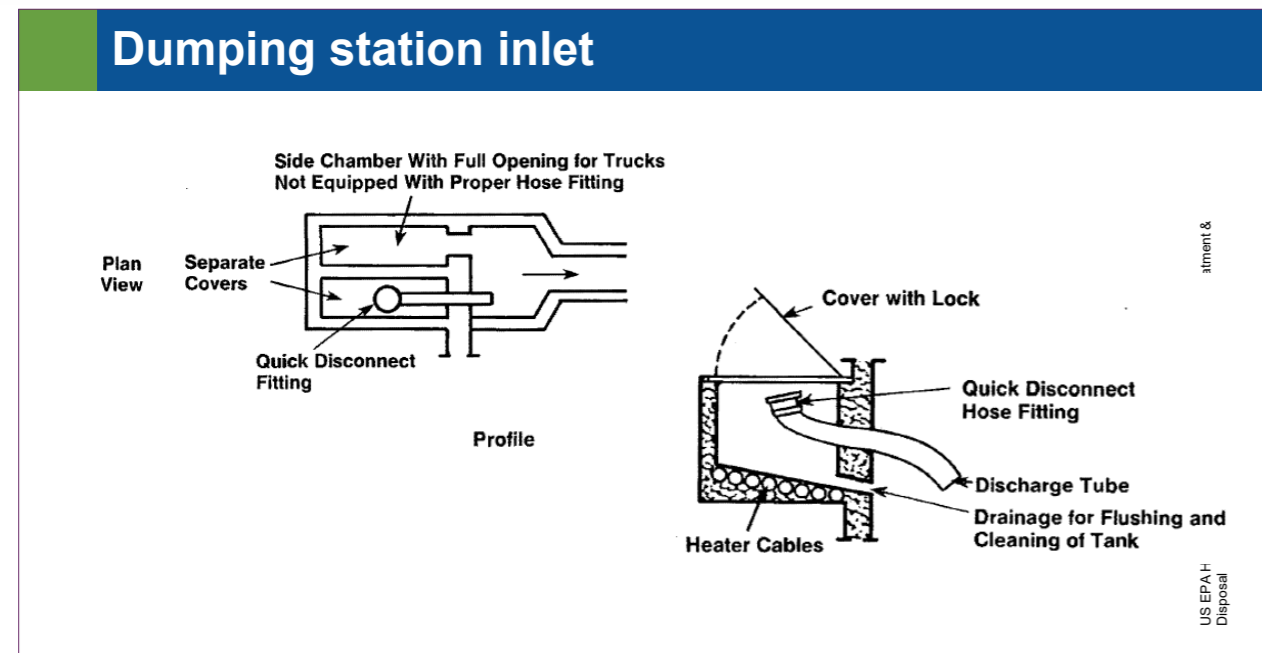

The most important component of the dumping station is a dumping inlet. The dumping inlet has two parts, (1) Pipe with a quick disconnect fitting and (2) Chamber for trucks which are not equipped with proper hose fittings.

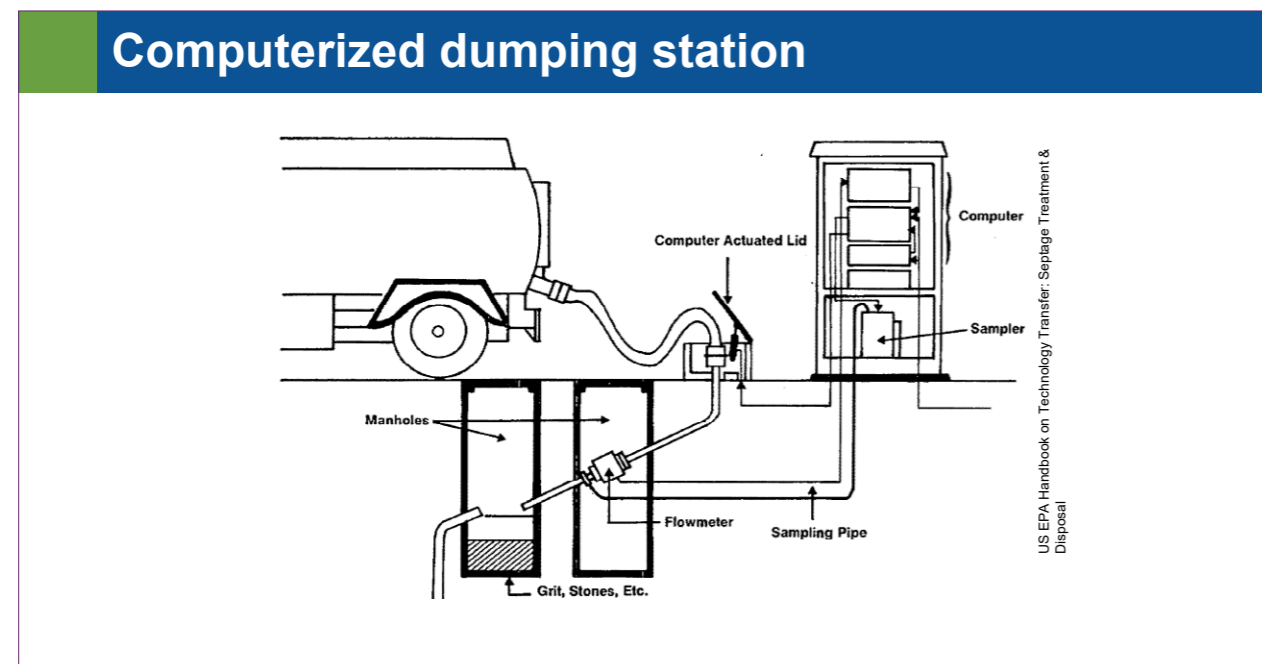

In developed countries, few receiving stations have computerized dumping stations. The driver has a card which he swipes in to the machine to gain access to the dumping inlet. The computer registers the date, time, driver details and measures the volume of the septage dumped. Few stations are equipped with sampling arrangements, which sample the septage and registers the parameters such as pH, temperature, COD and BOD. This curbs down manual intervention and data is collated over a stipulated period.

### 3. Odour control unit

Chemical scrubbers are used where the receiving stations are located near the residential / commercial areas and odour nuisance can possibly pose a threat to the operation of the receiving station. It is always recommended that even if the receiving station is not located in the residential areas, space should be allocated for the scrubbers to be placed in future if need be.

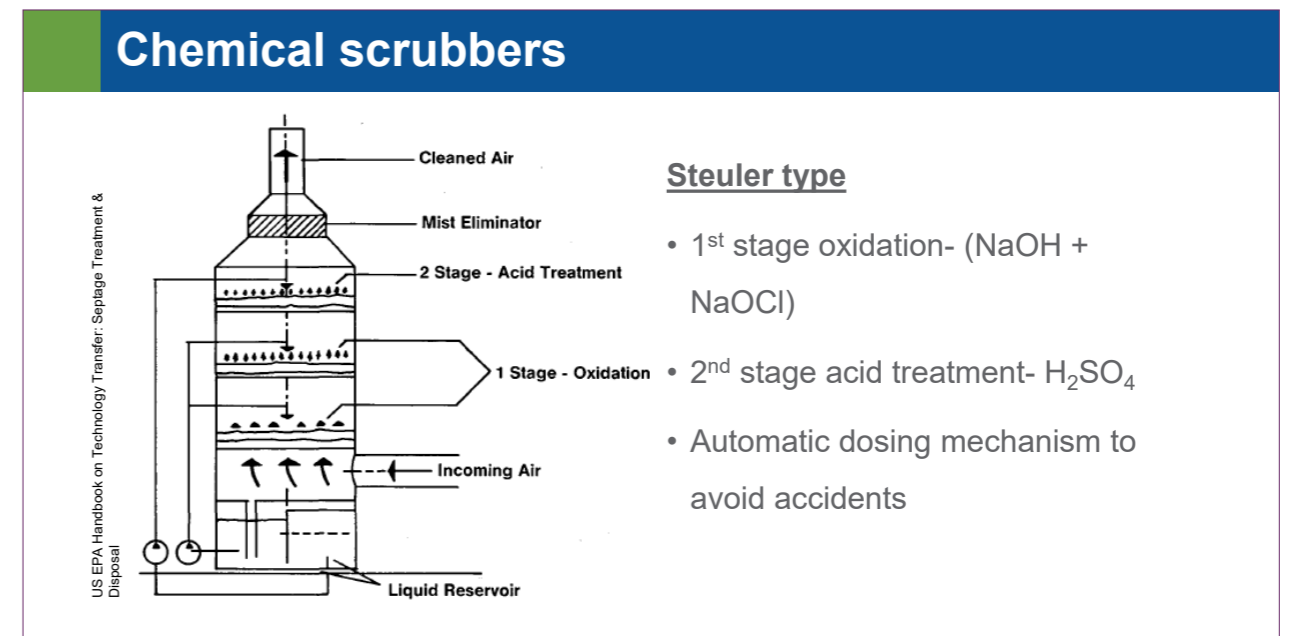

Chemical scrubbers are of two types, Steuler and Pepcon type. In Steuler type there are two stages. Firstly, oxidation of the compounds generating the odour are oxidised completely and then the air is passed through acid wash which strips down the remaining constituents. The clean air is now okay to be disposed. In this case the dosing of the chemicals should be done automatically in order to avoid any type of accidents during the handling.

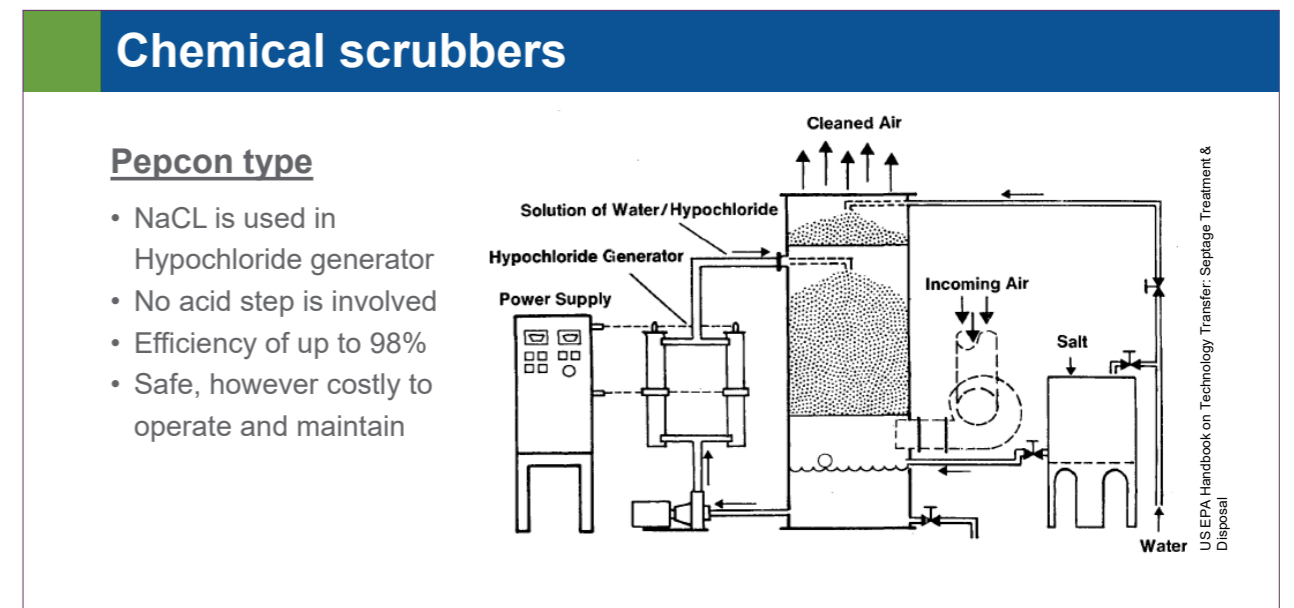

In Pepcon type of chemical scrubbers, the air is passed through hypochloride steam which deodorize the air. The hypochloride is generated by electrolysis of NaCl which is easy to handle and store at the site. The efficiency of this scrubber is up to 98%.

Chemical scrubbers are expensive for operation and maintenance. There are cases where the 2/3 of the O&M cost of the receiving station is contributed by chemical scrubbing equipment.

## Activated Charcoal Filter

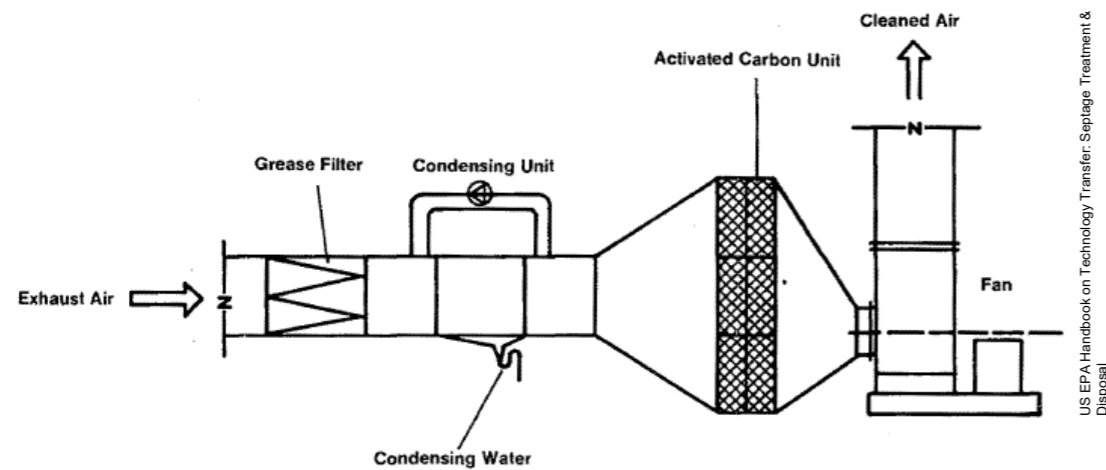

US EPA Handbook on Technology Transfer: Septage Treatment & Disposal

Activated charcoal filters are easy to operate and maintain. They are passive filters where the exhaust air passes through grease filter followed by condensation unit and then through activated charcoal filter. The grease filter and condensation unit are essential for proper functioning and long life of the Activated Charcoal filter. The filters need to be replaced completely at the end of its life. Since no hazardous chemicals are involved, these filters are easy to operate and maintain.

### 4. Types of Receiving Station

#### Receiving station- Option 1

Pre treatment at headworks of STP

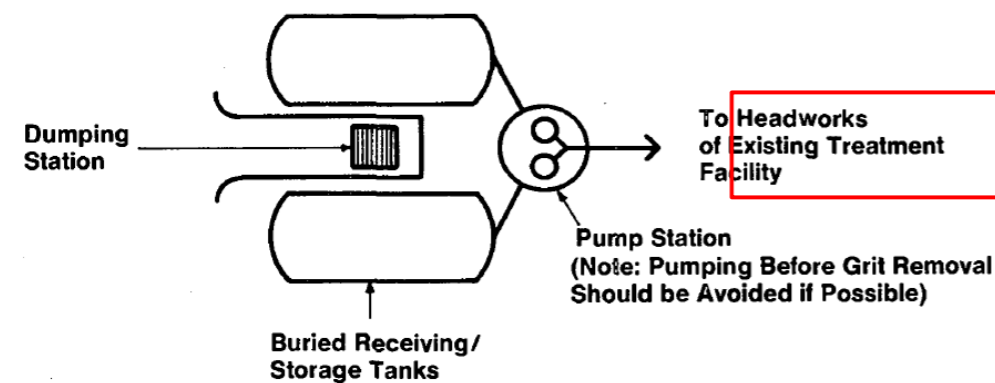

Such receiving stations are designed where the headworks of the STP are well equipped with well unutilised. In such cases the main objective of the receiving station is to safely transfer the raw septage from the hauler trucks to the headworks in a controlled manner. Post which the raw septage will pass through screening, grit removal at the head works of the STP.

#### Receiving station- Option 2

Pre treatment before equalisation

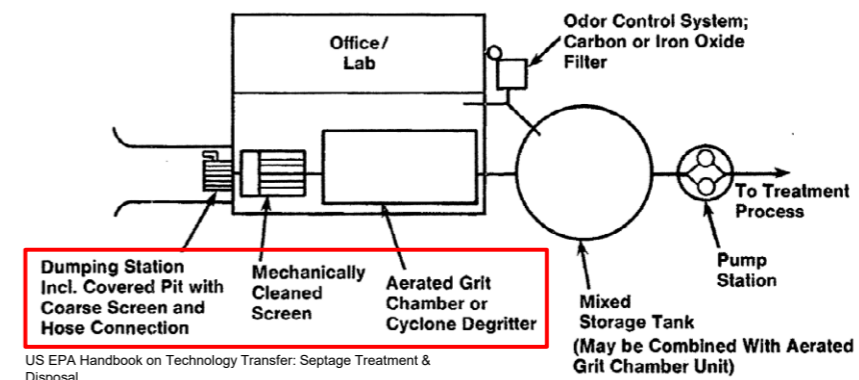

US EPA Handbook on Technology Transfer: Septage Treatment & Disposal

Such receiving stations are designed for handling smaller loads of raw septage. The receiving station is supposed to attain all the objectives i.e. safe transfer of raw septage, screening, degritting and controlled addition of the pre-treated septage into the headworks of the STP. An odour control system is optional, however, it is recommended to allot a space in the design so that in future it can be added.

During the design of screens and grit chamber, one needs to understand how many trucks will be dumping the raw septage simultaneously and appropriately estimate the hydraulic peak flow. To avoid over design of the screening and grit chamber, such receiving stations are recommended for handling small loads.

#### Receiving station- Option 3

Pre treatment after equalisation

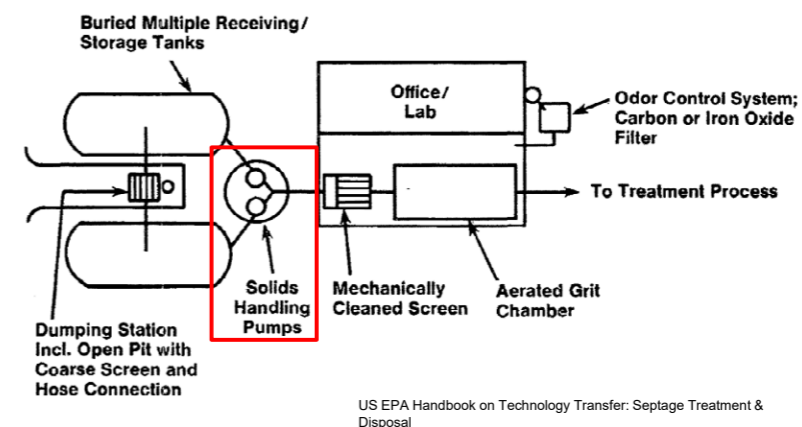

US EPA Handbook on Technology Transfer: Septage Treatment & Disposal

These types of receiving stations are recommended where large quantities of septage needs to be handled. Cases where large quantities of the hauler trucks are going to empty the raw septage, it is logical to store the raw septage and then feed to the screen in a controlled manner. In this way the design of the subsequent treatment (screens and grit chamber) will be dependent on the max flow the pump output has. This also reduces O&M and malfunctioning of the screens and grit

chamber. However, it has to be noted that the pump used here needs to be able to handle high amounts of grit (alternatively sludge pumps can also be used).

## Summary

- Aim of having a receiving station is to safely transfer the septage to the treatment facility.
- A properly designed receiving station eases the tipping of the septage from the truck in to the plant.
- Each component at the receiving station have a specific function of pre treating the septage and faecal sludge.
- Pre-treatment before equalisation is highly recommended.

## Links to the videos

- [Septage Receiving Station](#)
- [WAM Group- The BEAST](#)
- [Case Study: EUCA Septage Receiving Station](#)
- [Mini Screen Receiving Station](#)
- [Honey Monster Septage Receiving Station](#)
- [Parkson Combi Treatment & Septage Receiving Station](#)
- [Huber Complete Plant ROTAMAT Ro5](#)

Session

13

# Preliminary Treatment of Faecal Sludge & Septage

## Learning objectives

In this session we will discuss preliminary treatment of septage which is recommended in case of co treatment of septage with sewage.

We will introduce to mechanised equipment for pre-treatment of septage which are compact and highly efficient

## Contents

- **Screening**
  - Manual raked bar screens
  - Operational and design considerations
  - Disposal of screening
- Grit removal
  - Parabolic grit channels
    - Operational and design considerations
  - Vortex separators
  - Disposal of grit

### 1. Screening

## Manual raked bar screen

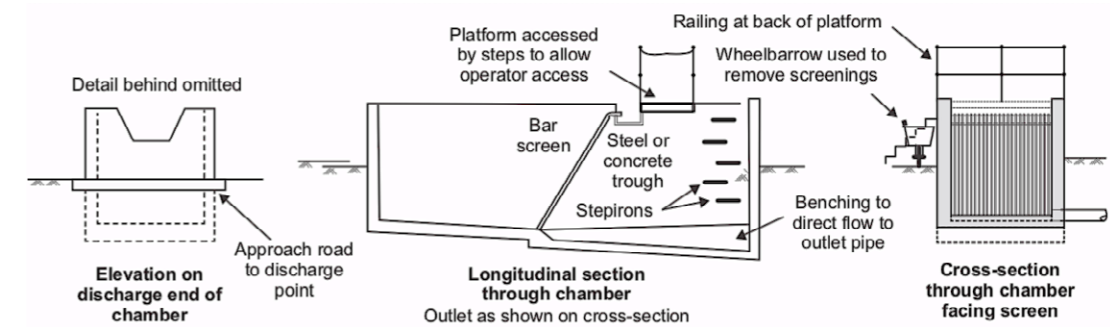

The slides show the manual rakes bar screen. In case of faecal sludge and septage treatment plants screening is performed in a channel fitted with a bar screen as shown in the picture. In cases where the inflow of septage is high, such channels should be constructed in civil masonry.

Bar screens should be fitted with a screen of appropriate size and should have appropriate slope in order to drain of the septage into the outlet pipe. A provision should be made operator to stand on while manual raking of screens. Appropriate safety rails should be provided to avoid any accident during FSTP operations.

## Operational and design criteria

1. Two screen should be provided
2. Sloped longitudinally towards outlet with benching
3. The screen bars runs top to bottom
4. Screen should be inclined between 45° – 60°
5. Screens to be coated with paint, epoxy or tar

Operational and design criteria of the screens are given in the slide above. In case of FSTP, a single screen is of appropriate bar spacing is sufficient. However, for operational ease, it is recommended to have two screens- coarse and fine. The bar screen should be sloped towards the outlet. The bars on the screen should run from top to bottom without any support in between. This ensures that raking can be performed in a single stroke without lifting the rake. The screen should be inclined between 45° – 60°. To avoid rusting of the iron bars, a coat of paint, epoxy or tar is recommended.

## Operational and design criteria

- Taper the bars slightly inwards from front to back
- The bars should be bent over at the top
- Paved path for container or wheel barrow
- Platform behind the screen for the operator to stand
- Step irons or ladder to access the deeper chambers
- Water point with hose connection

It is recommended that each bar should have slight tapering in the inward direction from front to back. The bars should be bent inwards at the top from the safety concern. There should be paved path for the container, so that it can be towed easily when full. The platform with adequate width and safety rails is very important. This ensures ease of operation and maintenance of screens. Step irons or ladder should be provided in case of the channels are deeper than 3 feet. A water point hose connection is recommended to wash the screens and channel whenever needed.

## Design criteria for bar screens

<i>Item</i>	<i>Unit</i>	<i>Manually cleaned</i>	<i>Mechanically cleaned</i>
<b>Bar width</b>	mm	5–15	5–15
<b>Bar depth</b>	mm	25–40	25–40
<b>Clear spacing between bars</b>	mm	25–50	15–75
<b>Angle to horizontal</b>	degrees	45–60	60–90
<b>Approach velocity</b>	m/s	0.3–0.6	0.6–1
<b>Allowable head loss</b>	mm	150	150

Crites and Tchobanoglous (1998)

The slide shows the design criteria for bar screens- manual and mechanical. It can be seen that mechanical screens have higher range of clear spacings for the bars. Since the raking is done mechanically, the mechanical screens can also be placed in almost 90° to the incoming flow of the septage.

## Prefabricated manual bar screen

### Features

- 4" – 6" quick disconnect fitting
- Flow diverter
- V Shaped screen
- Manual raking
- Solid waste to be pushed in the channel
- Collection in a bin or wheel barrow



Source: Screensystems

Manual screens are used for smaller receiving station. Usually these screens are developed for emptying on single truck at a time. It has a 4-6 inch quick disconnect fitting which eliminates chances of spillage. The flow diverter is provided which eliminates any splashing of septage while emptying. Also it even distributes the septage over the screen which eliminates the chances of choking of screen. The V shaped screen can accommodate higher flow and is easier to rake. The solid waste which is caught in the screen is raked manually into the channel which has holes in the bottom. Thus the waste which is leaching septage will also get captured and is drained into the pan below. The solid waste then has to be pushed into a bin or wheelbarrow.



## Disposal of screenings

- Sanitary landfill
- Temporary screenings are stored at site and transferred to landfill
- Reserve a area > impermeable liner > leachate drainage system
- Mechanical screens
  - Washing of screenings
  - Compacting of screenings
  - Bagging

The screenings are recommended to be disposed off into a sanitary landfill. After screening of septage the screenings are stored at the FSTP and are allowed to drain off before transporting to the landfill. In case a landfill is not available, reserve an area at the plant, excavate and put an impermeable liner and install a leachate collection system. This leachate can be co treated with the liquid effluent at the FSTP. Mechanical screens do come with optional mechanisms for washing of screening, compacting and bagging. This eliminates physical contact with the screenings and makes the process safe.

## Prefabricated mechanical screen



Source: WAM Group

### Features

- 4" – 6" quick disconnect fitting
- Removal of stones and heavy object
- Shredding of solid waste
- Mechanical drum fine screen
- Screw conveyor for solid waste
- Automatic washing system
- Compacting of solid waste
- Washed solid waste is collected in a bin

The mechanical screens are used where human intervention needs to be completely eliminated and higher flows need to be accommodated. A 4-6 inch quick disconnect fitting is provided which ensures there is no spillage. Stone and heavy object removal can be done however it is optional. This is followed by a shredder which shreds the solid waste such as rags, plastics etc to appropriate size. The mechanical drum ensures that all the solid waste is arrested and disposed into the screw conveyor which washes, compacts and transfers the waste to the bin or bag.

## 2. Grit Removal

### Considerations for grit removal

Grit removal should be considered

- At treatment plant catering to significant flows of septage
- Where large amount of grit is expected, sludge from unlined septic tanks or pits
- Subsequent treatment includes enclosed tanks such as digesters or mechanical equipment

Treatment facilities which are planning to handle larger volumes of septage on a daily basis should consider grit removal. It is also recommended to have grit removal where septage is expected to come from septic tank and pits which are not lined. Grit removal ensures removal of solids with high specific gravity which are usually non-biodegradable and suspended in the liquid fraction. This can also be considered as one way of solid liquid separation. After degritting the septage, it can be further sent for treatment.

### Parabolic grit channels

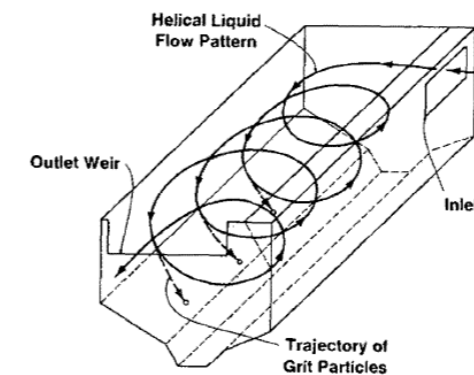

HUBER Longitudinal Grit Trap ROTOMAT Ro6

Longitudinal grit traps are used where high flows are expected. The septage after screening moves in the helical shape as shown in the figure on the left. During this movement, the grit settles down in the channel provided below. Aerated grit chambers are also used to improve the separation of the grit from the septage. There is screw conveyor at the bottom which collects all the grit to one end of the grit chamber from where is removed, washed and dried before collecting in a bin.

## Vortex separators

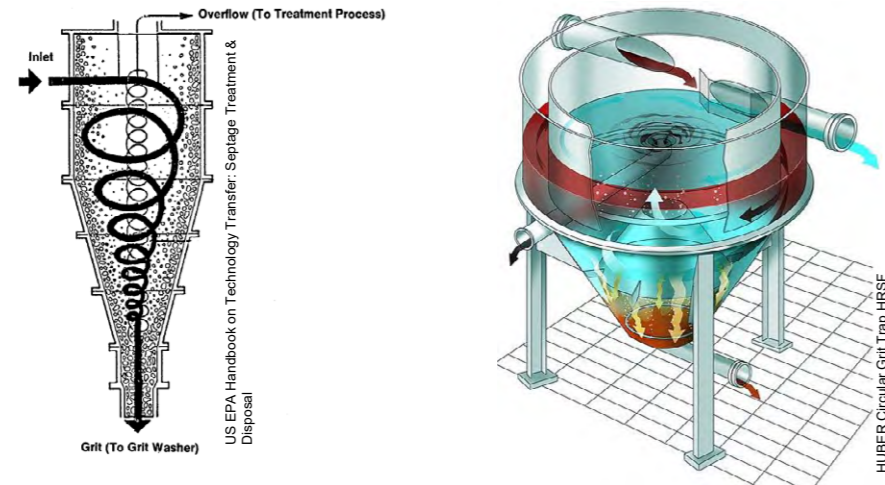

Cyclone degritters are used where large volume needs to be treated and not much space is available. These degritters are vertical in shape and can be put underground too. However, in that extra screw conveyor is needed for removing the grit to the top or a pump is used. One more advantage of the cyclone degritter is that it can also separate oil, grease and fat from the septage. Cyclone degritters are becoming more and more popular due to their compact size.

## Grit disposal

- Grit is usually disposed at the sanitary landfill
- In case of faecal sludge and septage,
  - Organic content of the grit is high
  - Washing of grit is necessary before disposal
  - Odour under control
  - Easy to handle and dispose
- Mechanical grit removal equipment provides washing and bagging of grit

Grit consists of particulate mostly inorganic matter. In case of faecal sludge the organic content of the grit might be high. Hence it is recommended to have washing of grit. The wash water can be drained off into the septage further to the treatment system. This also ensures that there is no odour and leachate nuisance from the grit, making it more easy to handle and dispose. Mechanical grit removal equipment provides automatic washing unit and bagging. This eliminates contact and manual labour for handling grit at the FSTP.

## Integrated Pretreatment Module

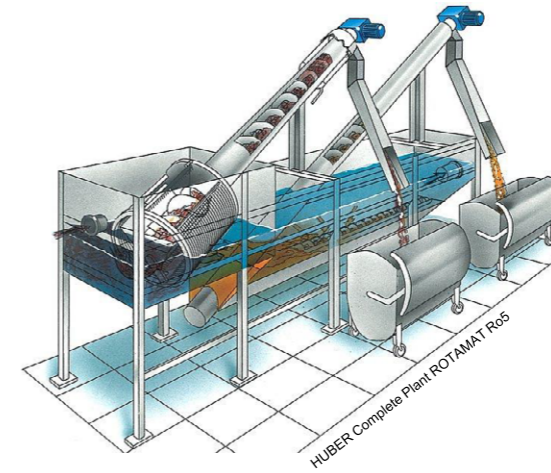

### Features

- Fine screening with washing and dewatering
- Grit aeration, separation, dewatering and washing
- Removal efficiency with  $Q_{max}$ : 90% (particle diameter 0.2 – 0.25 mm)
- Capacity up to 300 l/s
- No odour nuisance
- Completely made of stainless steel

Integrated pre-treatment module combines the mechanical screen and longitudinal grit trap. This is a single equipment which can be placed after the dumping station. Washing, and dewatering is optional and is recommended so that the solid waste and grit can be safely handled and disposed appropriately.

## Links to the videos

- [WAM Group- The BEAST](#)
- [Mini Screen Receiving Station](#)
- [Parkson Combi Treatment & Septage Receiving Station](#)
- [Huber Complete Plant ROTAMAT Ro5](#)

Session

**14**

# **Mechanized Dewatering Units**

---

## Learning objectives

In this session, we are going to see the different mechanical dewatering equipment and the approach to choose the appropriate model.

## Contents

- Introduction
- System description
- Performance
- Operation and design consideration
  - Comparison: Screw press v/s Belt filter press
  - Design criteria and procedure
- Exercise
- Videos

### 1. Introduction

## Introduction

- Have been used for dewater sewage sludge in STPs
- Require less area as compared to non mechanized dewatering units
- Reliable electricity required
- Energy requirement of centrifuge > press

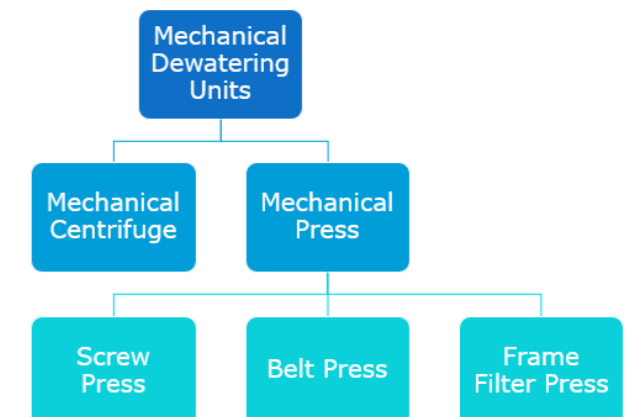

Mechanical dewatering equipment have been used for dewatering of sewage sludge in STPs. This equipment requires significantly less area as compared to natural dewatering units such as drying bed. The mechanical dewatering units are mainly of two types, centrifuge and press. Mechanical centrifuge is quite efficient & are mostly appropriate for STP where huge quantum of the sludge needs to be handled. Moreover, the energy requirement of centrifuge is more as compared to press. The mechanical presses are more suitable for faecal sludge and septage. The mechanical presses are of three types, screw press, belt press and frame press filter. Reliable electricity supply is required for operating this equipment.

Hence, mechanical dewatering equipment are suitable in cases where less area is available and variation in sludge received at the treatment facility is high. It is also suitable where high volume of septage will be received, because in this case the area requirement of natural treatment units is quite high.

## 2. System Description

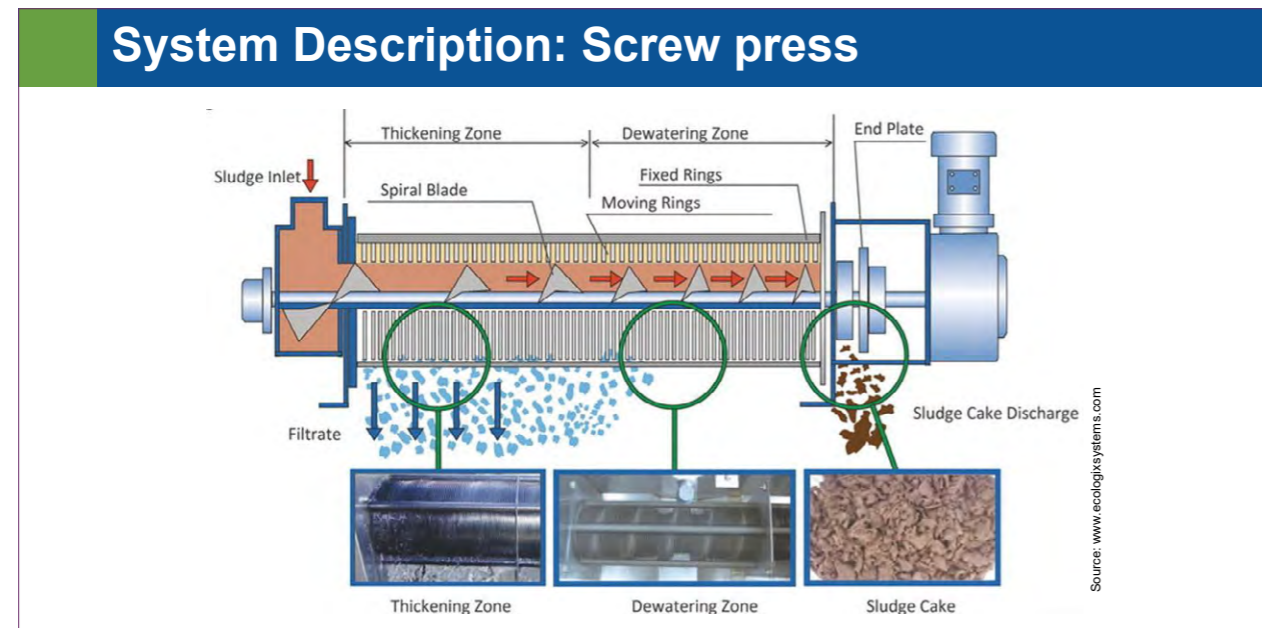

Screw presses separate liquid from solids by forcing sludge through a screw or auger contained within a perforated screen basket. The screw diameter increases with distance along the shaft while the gap between its blades decreases so that the gap between basket, shaft, and flights continuously decreases and sludge is squeezed into a progressively smaller space. This results in an increase in pressure along the press. Pressure probes are used to control and monitor the pressure to ensure treatment performance. The inclined press includes a pneumatic or manually adjusted counter-pressure cone that maintains a constant sludge pressure at the discharge end of the press. The water squeezed from the sludge drops into a collector channel at the bottom of the press, which conveys it to the next stage of treatment. The dewatered cake drops out of the end of the press for storage, disposal, or further drying on a drying bed or in a thermal dryer. High-pressure water is used periodically inside the press for cleaning.

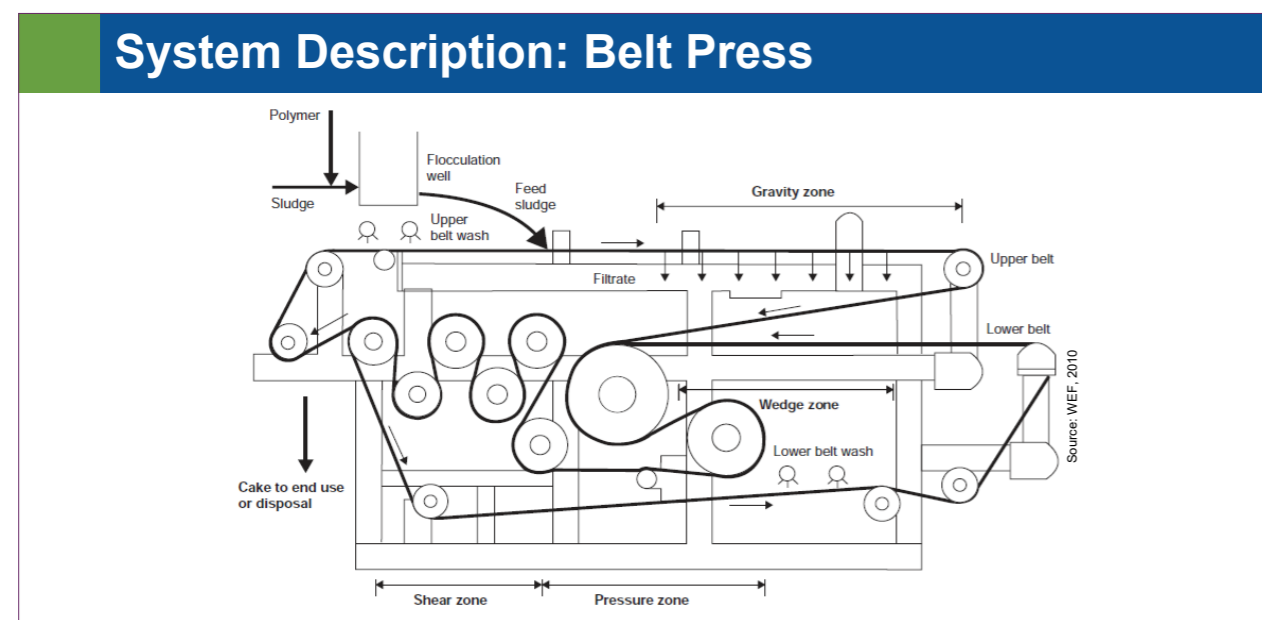

Belt filter presses separate liquid from solids, using gravity and applied pressure between fabric belts. The process typically involves four steps: preconditioning, gravity drainage, low-pressure linear compression, and high-pressure roller compression (and shear). After preconditioning, sludge passes through a gravity drainage zone where liquid drains by gravity from the sludge. It is then moved on to a low-pressure zone where two belts come together to squeeze out the liquid from the solids, forcing liquid through the fabric belts. In most cases, the sludge is then subjected to higher pressure as it is forced between a series of rollers, which creates shearing forces and compression to further dewater the sludge.

The dewatered sludge cake is then scraped off the belts for conveyance to the next stage of treatment or disposal. The belts are cleaned with high-pressure wash water after each pass.

## 3. Performance

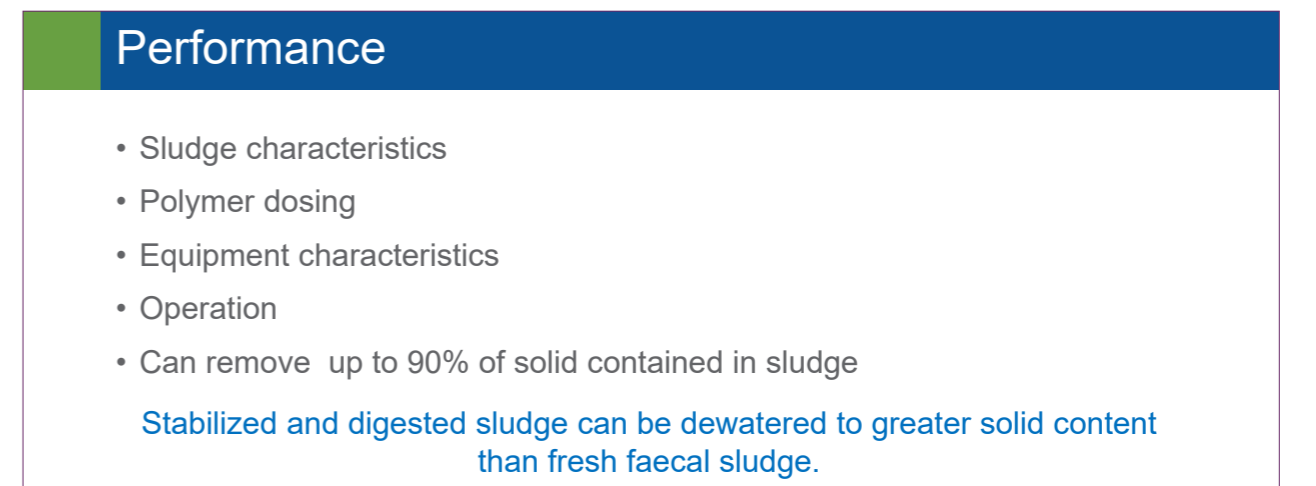

The performance is highly dependent on the sludge characteristics and its dewaterability. Hence, polymer dosing is recommended to condition the sludge. Equipment characteristics such as type of belt and spacing of blades etc also have an impact on the dewatering efficiency. However, these are fixed by the manufacturers after performing research and development. Operation of the equipment refers to operational parameters such as pressure of the end plate or the compaction pressure in case of belt press. These parameters are variable and it is upto the operator to change depending upon the sludge characteristics.

The performance efficiency of the mechanical dewater equipment is quite high. It can remove up to 95% of the solid contained in the sludge if operated optimally. It needs to be kept in mind that dewaterability of the septage is quite high as compared to that of faecal sludge.

#### 4. Operation & Design Considerations

### Operation and design considerations

- Manufacturer support during selection and design
- Pre treatment requirement for effective operations
  - Removal of grit and gross solids
  - Flow balancing and mixing
  - Conditioning with polymer
- Reliable source of clean and pressurized wash water

It is always recommended to get in touch with an expert/manufacturer for selection of proper equipment. Since there are certain design parameters which are fixed by manufacturers after performing research and development, it is wise to know these constraints before finalising the equipment for treatment. In most cases pre-treatment of sludge is recommended. Pre-treatment might consist of removal of grit and gross solids. Grit is responsible for wear and tear of the equipment. Gross solids might result in clogging or breakdown down of the equipment/pumps. Conditioning of polymer is also recommended so as to have solids concentration between 1-2% consistently to the dewatering equipment. All the dewatering equipment demand reliable source of clean and pressurized water for washing the dewatering parts (casing, belt etc).

### Operation and design considerations

- Performance should be continuously monitored
  - For adjusting polymer dosage
  - Early detection of problems
  - To maintain inventory of consumables and spare and replacement parts
- Need of maintenance and repair
  - More than one unit to be installed
  - Area around the unit

Operation of the mechanical dewatering equipment demands continuous monitoring. Monitoring is needed to ensure proper conditioning of the sludge before it goes for dewatering. Also it helps to have early detection of problems and maintain inventory of consumables and spares of the equipment. Preventive maintenance is utmost important in case of mechanical equipment. Preventive maintenance helps to prevent complete breakdown of the equipment. To carry out preventive maintenance, it is very important to have more than one equipment (if the equipment is needed on a daily basis and quite frequently). Area around the unit needs to be kept for movement of the mechanic and hauling of the parts etc.

### Operation and design considerations

- Environmental and health concerns
  - Screw press are compact and enclosed
  - Belt filter press can be either open or enclosed. Open configuration;
    - Is cheaper
    - Allows inspection
    - Facilitates access for parts
  - Minimize hazard from odour, harmful gases, pathogens

There are certain environmental and health concerns which needs to be considered while selecting appropriate equipment. Screw press are quite compact and completely enclosed. Hence there are very few concerns pertaining to bio safety or odour. Belt press however are available with or without enclosure. Although, the press without enclosure is cheaper, allows easy inspection during its operation and facilitates access to parts during preventive maintenance; there are hazard related to odour, gases and pathogen.

#### 5. Comparison: Screw Press v/s Belt Filter Press

### Comparison of units

Technology	Operation	Maintenance
Screw press	<ul style="list-style-type: none"> <li>• Intermittent medium pressure wash water (&lt;10% sludge flow rate at 4 bar pressure)</li> <li>• Simpler operation</li> <li>• Enclosure keeps surrounding environment clean and safe</li> <li>• Low Energy consumption</li> </ul>	<ul style="list-style-type: none"> <li>• Fewer parts to monitor and maintain</li> <li>• Less inventory to maintain</li> </ul>
Belt filter press	<ul style="list-style-type: none"> <li>• Continuous wash water (50-100% sludge flow rate at 8 bar pressure)</li> <li>• Unenclosed units are messy to operate and present health hazard; however, allow visibility of process performance.</li> </ul>	<ul style="list-style-type: none"> <li>• Simple equipment to maintain (rollers, bearing, belt)</li> <li>• More parts to monitor- inspect and maintain</li> </ul>

The above slide present comparison between screw press and belt press filter depending on operation and maintenance. It can be realised that screw press are easy to operate and monitor. Although a small inventory of spares need to be maintained, the maintenance procedure itself is quite tedious. Hence, proper trained professionals are required for undertaking the maintenance of the units.

Belt press on the other hand has a very simple mechanism and hence its maintenance is easy to perform. However, there are more number of moving parts and hence bigger inventory needs to be maintained.

## Comparison of units

Technology	Dewatering performance	Cost
Screw press	<ul style="list-style-type: none"> <li>Can receive sludge with low solid content (&lt;1%)</li> <li>15-25% final dry solids</li> <li>Less sensitive to non homogenous sludge characteristics</li> </ul>	<ul style="list-style-type: none"> <li>Higher capital costs</li> <li>Slightly lower operation cost</li> </ul>
Belt filter press	<ul style="list-style-type: none"> <li>Can receive sludge with solid content &lt; 0.5%</li> <li>15-25% final dry solids</li> <li>Can be provided with greater capacity for single unit</li> </ul>	<ul style="list-style-type: none"> <li>Lower capital cost</li> <li>Slightly higher operating cost</li> </ul>

The slide shows comparison of screw press and belt press filter depending upon the dewatering performance and cost. The performance of both the equipment is more or less the same, however screw press is more robust towards non homogenous sludge as compared to belt press. Belt press on the other hand can cater to higher volumes of sludge per hour as compared to screw press.

The capital cost of the screw press is little higher as compared to belt press, however, the operation cost is lesser than the belt press.

### 6. Design Criteria & Procedure

## Design criteria and procedure

Parameter	Symbol	Screw Press	Belt filter press
Solids loading rate	$\lambda_s$	15 - 1,900 kg/h	180 - 1,600 kg/h m
Hydraulic loading rate	$\lambda_l$	0.3 - 48 m <sup>3</sup> /h	6 - 40 m <sup>3</sup> /h m
Belt width	$W_b$	Not applicable	0.5 - 3.0 m
Polymer dose	$C_p$	3 - 17.5 g polymer/kg dry solids	
Operating time per day	$t_{op}$	4 - 12 hours / d	

The slide provides standard ranges for various parameters used for selection of appropriate model of dewatering equipment.

## Design criteria and procedure

Determine the peak and average daily volumetric loading and peak daily mass loading

$$m_{sp} = Q_{sp} \times TSS$$

$$m_{sm} = Q_{sm} \times TSS$$

where;

$Q_{sp}$  = peak daily volume of septage delivered for treatment in m<sup>3</sup>/d

$Q_{sm}$  = mean daily volume of septage delivered for treatment in m<sup>3</sup>/d

TSS = suspended solids concentration of the incoming septage in g/l

$m_{sp}$  = peak daily dry solids loading in kg/d

$m_{sm}$  = mean daily dry solids loading in kg/d

The manufacturers / experts expect to know basic details such as peak and average daily volumetric and mass loading on the dewatering equipment. Hence it is of utmost important to estimate the quantity and quality of the sludge before consulting the manufacturers.

## Design criteria and procedure

Calculate the peak hourly hydraulic and solids loadings on the presses

$$Q_{sph} = Q_{sp} / t_{op}$$

$$m_{sph} = Q_{sph} \times TSS$$

where;

$Q_{sph}$  = peak hour volume of septage to be treated (m<sup>3</sup>/h)

TSS = suspended solids concentration of the incoming septage (g/l)

$m_{sph}$  = peak hour dry solids loading (kg/h)

$t_{op}$  = number of hours for which presses will operate during a normal working day

In case of screw presses, mass of sludge to be dewatered during peak hour is adequate for manufacturer to suggest a suitable model available with them. In cases where the incoming sludge has solid content of less than 1%, in that case the peak flow is considered as a deciding parameter.

There are companies who also customize the equipment to your needs, however the cost of such customised equipment is high.

## Design criteria and procedure

In case of belt filter press

$$W_b = m_{sph}/\lambda_s$$

$$W_b = Q_{sph}/\lambda_l$$

where;

$W_b$  = total belt width required (m)

$\lambda_s$  = rated dry solids capacity of the belt press model being considered (kg/m h)

$\lambda_l$  = rated hydraulic capacity of the belt press model being considered (m<sup>2</sup>/m h)

In case of the belt press, the deciding factor is the rated dry solids capacity and rates hydraulic capacity of the belt used in the belt press. Depending upon these two parameters, the maximum required width of the belt is decided.

## Design criteria and procedure

Polymer dosing requirement

$$m_{polymer, day} = m_{sp} \times C_p/1000$$

$$m_{polymer, year} = m_{sm} \times C_p \times D/1000$$

where;

$M_{polymer, day}$  = maximum daily polymer requirement (kg)

$M_{polymer, year}$  = yearly polymer requirement (kg)

$C_p$  = polymer requirement (g polymer/kg solids in septage)

$D$  = number of days in year for which the plant is operational (d/year)

Polymer dosing is also suggested by the manufacturer. Polymer dosage is provided by the manufacturers which can be used to calculate daily and annual consumption of polymer.

## 7. Exercise

### Exercise

Consider a screw press requirement to provide solid liquid separation for a treatment plant designated to receive 150 m<sup>3</sup> of septage for 5 days per week for 52 weeks of the year.

Parameter	Symbol	Value	Units
Operation time	$t_{op}$	8	h/d
Peak hydraulic load	$Q_{sp}$	150	m <sup>3</sup> /d
Mean hydraulic load	$Q_{sm}$	100	m <sup>3</sup> /d
Influent solids content	TSS	20	Kg/m <sup>3</sup>
Polymer requirement	$C_p$	10	g/kg dry solids

### Answers

$$m_{sp} = 3000 \text{ kg/d}$$

$$m_{sm} = 2000 \text{ kg/d}$$

$$Q_{sph} = 18.75 \text{ m}^3/\text{h}$$

$$m_{sph} = 375 \text{ kg/h}$$

$$m_{polymer, day} = 30 \text{ kg/d}$$

$$m_{polymer, year} = 5,200 \text{ kg/year}$$

Provide two screw presses with capacity of not less than 18.75 m<sup>3</sup>/h or three screw presses with capacity of not less than 9.4 m<sup>3</sup>/h.

or

$$W_b = 0.9375 \text{ m } (\lambda_s = 400 \text{ kg/h.m}),$$

$$1.25 \text{ m } (\lambda_l = 15 \text{ m}^3/\text{h.m})$$

Provide two presses with a 1.5 m belt width.

### Links to the videos

- [Screw press animation](#)
- [Volute screw press](#)
- [Working of a volute screw press](#)
- [Belt filter press animation](#)
- [Working of a belt filter press](#)



Session

**15**

# **Mechanized Drying Units**

---

## Learning objective

In this session we are going to see different types of sludge drying equipment based on solar and thermal processes. Although sludge drying might be a simple processes, natural drying required significant area and hence sludge drying aided with mechanized equipment is a good solution in cases where area is a constraint.

## Contents

- Introduction
- Solar drying
  - System description
  - Performance range
  - Operational and design considerations
  - Design criteria
- Thermal drying
  - System description
  - Performance range
  - Operational and design considerations
  - Design criteria and procedure

## Need of further treatment

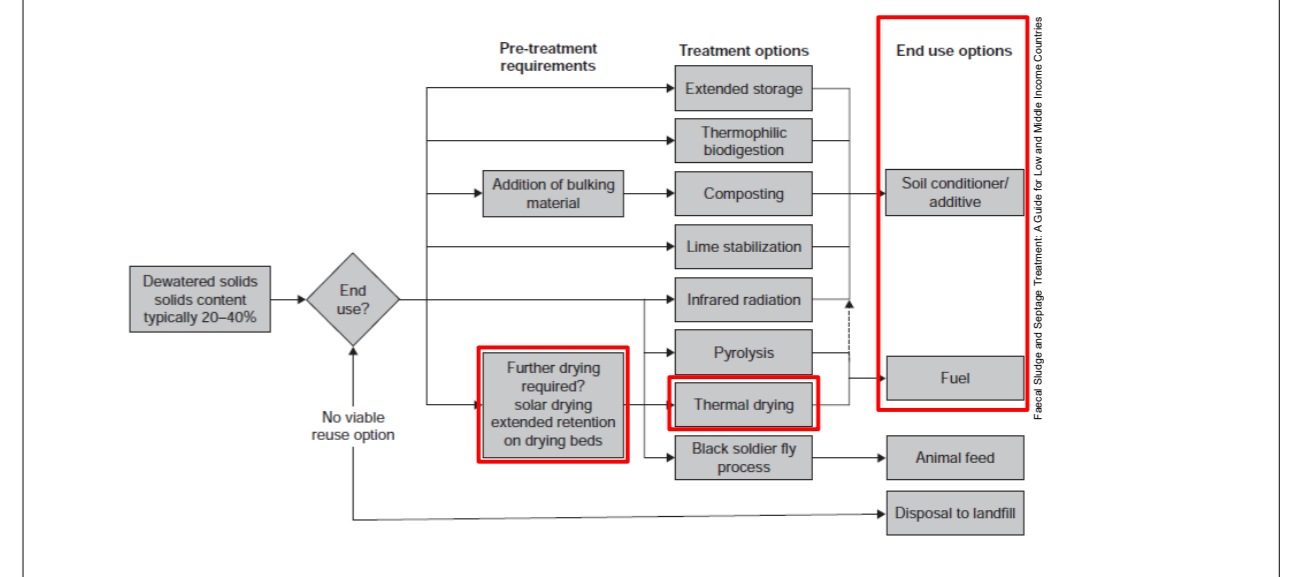

Dewatered sludge has a solid content typically in the range of 20 – 40%. However, if the end use of the solids is intended to be soil conditioner or fuel, these solids need to be further dried up to

60% solid content. Drying also helps in pathogen reduction by various ways such as starvation, desiccation or temperature.

Dry solids requirement	
Treatment Process	Dry solid requirement
Combustion	At least 80%
Composting (moisture content: 55-60%)	40-45%
Thermal drying	High energy requirement for evaporation of water
Pyrolysis	High energy requirement for evaporation of water
Black soldier flies	10-40%

Faecal sludge and septage treatment: A guide for low and middle income countries by Kevin Taylor

The table in the slide shows requirement of the solid content in the sludge for its intended further end use. Hence, for combustion at least 80% solid content is recommended, whereas for composting solids content of at least 40% is required. In case of thermal drying or pyrolysis, since constant heat and temperature needs to be achieved in the chamber, addition of water reduces the temperature significantly. In this case, the water takes up a significant amount of heat energy for its own evaporation. Hence optimum drying of sludge is required before it goes for thermal drying or pyrolysis.

### 1. Introduction

**Introduction**

- Aim- (1) Removing water and (2) Reduce pathogen levels
- Methods- Solar drying and Thermal Drying

Pathogen requirement for biosolids reuse		
Organization	Guideline requirements	Source
World Health Organization	Helminth egg count: ≤1 egg per gram of total solids	WHO (2006)
	<i>E. coli</i> : ≤1 000 count per gram of total solids	
US Environmental Protection Agency (Part 503 biosolids rule)	Class A biosolids: faecal coliform density ≤1,000 per gram of total dry solids, or <i>Salmonella</i> subspecies (spp) density ≤3 per 4 grams of total dry solids	US EPA (1994)
	Class B biosolids: faecal coliform density ≤2,000,000 per gram of total dry solids	

Faecal Sludge and Septage Treatment: A Guide for Low and Middle Income Countries

As said earlier, the aim of sludge drying using mechanical equipment is to remove water and reduce pathogen levels in the sludge. For the sludge to be suitable for reuse or disposal, WHO and US EPA proposes certain standards. The standards are given in the slide above.

### 2. Solar Drying

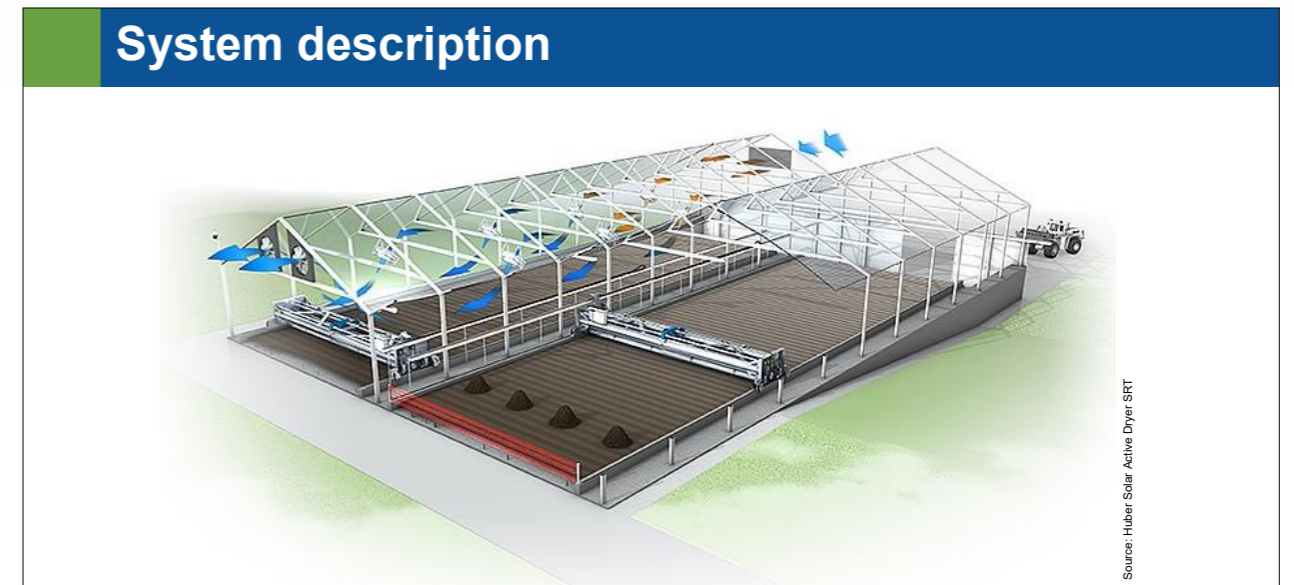

The slides show typical solar sludge drying house. Forced ventilation coupled with tilling equipment is used to drive out the moisture at a higher rate from the sludge. The material of used for preparing the covering (shed) is such that it allows the solar energy to get inside and get trapped. The solar energy heats up the dry air which absorbs the moisture from the sludge. The moisture laden air is then forced out of the house through the ventilation system.

**Performance range**

- Solar radiation, air temperature, relative humidity and depth of sludge
- Ventilation flux > Relative humidity
- Initial solid contain also affects performance of solar drying

**SLUDGE** → Solar Drying → **BIO SOLIDS**

20% solid content 7 days 70-80% solid content

The performance of solar sludge drying is dependent on solar radiation, air temperature, relative humidity of the air and depth of the sludge. The ventilation flux controls the relative humidity and accelerates the evaporation process of moisture from the sludge. The initial water content and depth of sludge also affects the performance of drying. To regulate the depth of sludge and to expose the maximum area of the sludge, tilling equipment is used, which tosses and turns the sludge while maintaining the height of the sludge and exposes it to the relatively dry air.

## Design criteria

$$E = 0.000461 R_0 + 0.00101 Q_v + 0.00744 T_0 - 0.22 \sigma + 0.000114 Q_m$$

where;

E: evaporation rate (mm/h)

$R_0$ : outdoor solar radiation (W/m<sup>2</sup>)

$Q_v$ : ventilation rate (m<sup>3</sup>/ m<sup>2</sup> h)

$T_0$ : air temperature (°C)

$\sigma$ : dry solids content (kg solids/kg sludge)

$Q_m$ : air mixing rate (m<sup>3</sup>/m<sup>2</sup> h)



Solar Radiation



Air Temperature

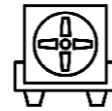

Ventilation Rate

The evaporation rate can be calculated using the formula given in the slide above.

## Design criteria and procedure

- Drying cycle time
  - Solid content of the incoming sludge
  - Evaporation rate
    - Solar radiation, air temperature and ventilation rate
  - Sludge depth
- Sludge Depth
  - 150-400 mm
  - Higher depth required mechanical tilling equipment
  - Ventilation rate
    - 150 m<sup>3</sup>/m<sup>2</sup>. h

The drying cycle time of the sludge depends on the initial solid content, evaporation rate which is dependent on solar radiation, air temperature and ventilation rate and sludge depth. The sludge depth can vary from 150 – 400 mm. However, it is recommended to have tilling mechanisms for higher depths such as 250 mm. A ventilation rate of 150 m<sup>3</sup> per square meter area of solar sludge drying house is recommended. However, it is completely dependent on the site conditions and should be adjusted accordingly.

## Operational and design consideration

- Requires mechanical equipment and a reliable electricity supply
  - Functioning of ventilation fans
  - Functioning of tilling device
- Number and configuration of drying beds
  - Multiple beds for sequential loading
  - At least one extra bed for ease of maintenance
- Maintenance needs
  - Green house covering needs to be cleaned regularly

Since mechanical equipment is used for forced ventilation and tilling, reliable source of electricity is required for operating the solar drying house. There should be multiple beds especially in places which have high humidity or significant variation in temperature on an annual basis. As a maintenance measure, the covering of the green house should be cleaned on a regular basis.

### 3. Thermal Drying

## System description

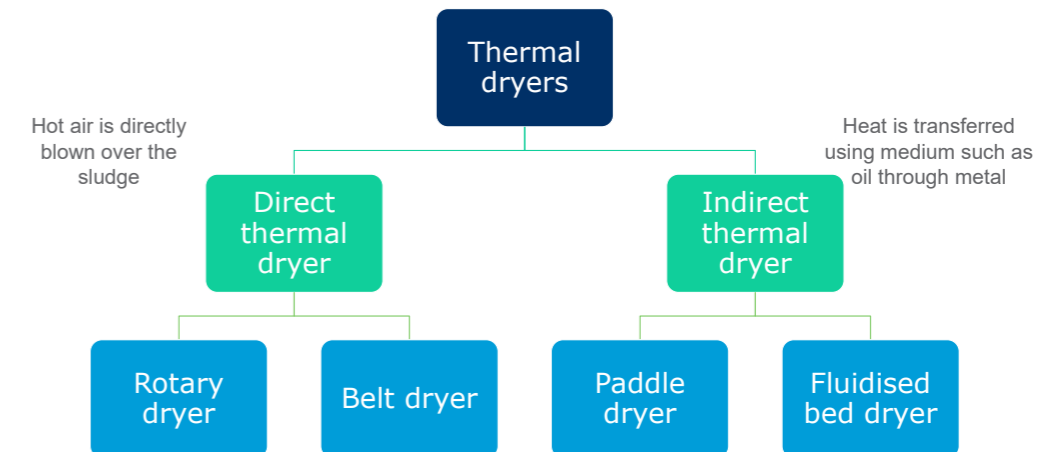

The slide shows different type of thermal dryers. There are basic two types- direct thermal dryer and indirect thermal dryer. Direct thermal dryer refers to the process where hot air is used to drive away the moisture. Indirect thermal dryer is referring to the process where heat is transferred using medium such as oil, sand etc.

## Performance range

- Initial solid content to be around 60% so that the sludge moves through the dryer without sticking
- The dried sludge has solid content of 90-95%



In case of thermal dryer, the initial solid content should be approximately 60%. This is required so that the sludge moves through the dryer without sticking to the walls. The dried sludge in the end has a solid content of 90-95%.

## Operational and design consideration

- Thermal dryers have a high energy requirement
  - 4.186 kJ per degree celsius – energy required to heat water
  - 2260 kJ/kg – energy required for vaporization
- Optimised operation- efficiency of more than 80%
- Health and safety considerations
  - More than 95% solid content - dust
- Operator training and skill requirements
- Manufacturer support

Thermal dryers have high energy requirements, since a tremendous amount of energy is required to heat the water and thereby vaporise it. However, thermal dryer requires significantly less area for processing the sludge. In optimised operation, efficiency of the dryer is more than 80% consistently. Health and safety consideration such as production of dust should be taken into account. Operators need to be trained properly and persons with definite skills are required for operating such equipment.

## Design criteria

$$E_{r,e} = \frac{[4.186 (100 - T_a) + 2260 (C_i - C_f)]}{\epsilon}$$

where;

$E_{r,e}$ : total energy required for evaporation (kJ/kg of wet sludge)

$C_i$ : water content of dewatered sludge

$C_f$ : water content of the dried sludge

$T_a$ : ambient temperature

$\epsilon$ : efficiency of the drying process

4.186 kJ/kg °C- energy required to heat water

2260 kJ/kg- energy required for vaporization

The total energy required for evaporation can be calculated using the formula given in the slide above.

## Rotary dryer

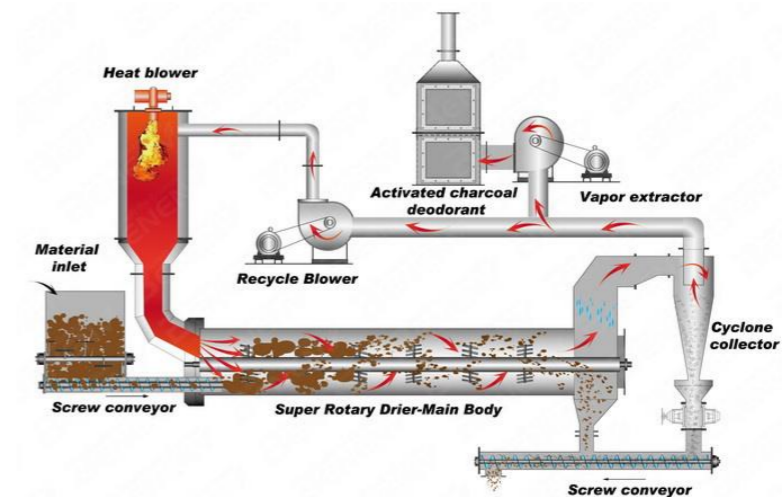

The simplest form of dryer is the direct rotary dryer. This consists of a cylindrical steel shell that rotates on bearings and which is mounted horizontally, with a slight slope down from the feed end to the discharge end. The feed sludge is mixed with hot gases produced in a furnace and is fed through the dryer. As it passes through the dryer, flights (fin-like attachments to the wall of the cylinder) pick up and drop the sludge, causing it to cascade through the gas stream. Moisture in the sludge evaporates, leaving a much dryer material at the discharge end of the dryer. The dried sludge is separated from the warm exhaust gas, part of which is recycled to the dryer while the remainder is treated to remove pollutants and is then vented to the atmosphere.

## Belt dryer

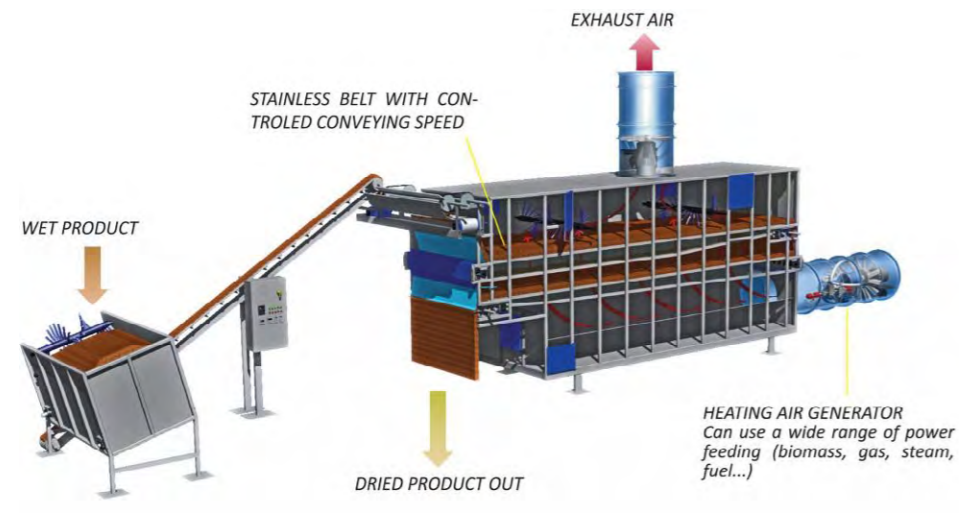

Belt dryers operate at lower temperatures than rotary drum dryers. The heat from the furnace is transferred to a thermal fluid, which heats the air in the dryer. The dewatered cake that is to be dried is distributed onto a slow-moving belt, which exposes a high surface area to the hot air.

## Paddle dryer

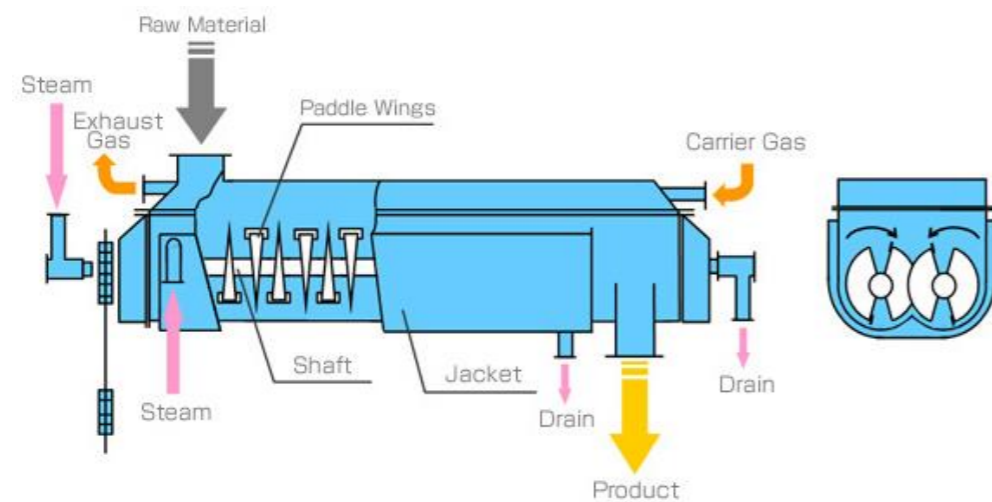

Paddle dryer has paddle wings which are hollow from inside so that steam can be circulated from it. The paddle system is also encompassed into a jacket which is fed by steam. When raw material is introduced into the paddle dryer, the heat is transferred from the paddles to the sludge. The sludge moves in the forward direction and get churned as it moves ahead. From the other end the dried solids come out of the dryer. Dry air is introduced in the jacket to drive away the moisture laden air out of the dryer.

## Fluidised bed dryer

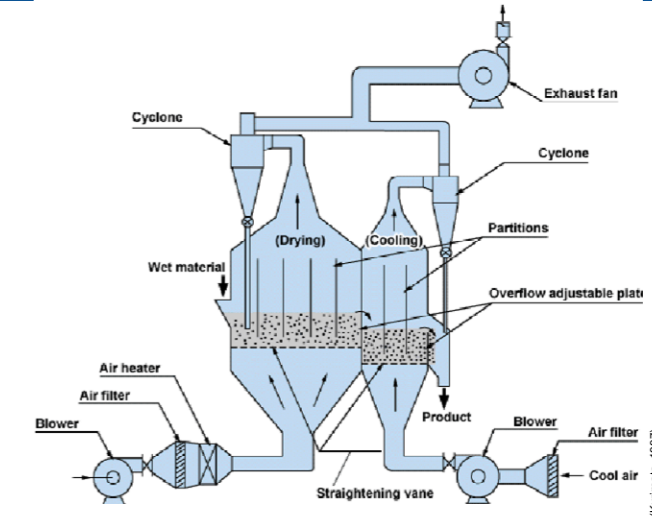

The fluidised beds have been used for drying Europe and the USA since the 1940s to create pellets of sludge. In this case the medium (sand) is heated and kept in fluidised state by introducing hot air in the reactor. The wet sludge is introduced in to the reactor and flash drying takes place. The heated solids are then cooled using cool air before they are taken out of the reactor. Here cyclone de-gritters are used to remove the dust from the hot and cold air coming out of the reactor. Fluidised bed reactor are quite complex to operate and its energy requirement is high too.

## Summary

- There are two types of drying equipment available for drying of dewatered sludge- solar drying and thermal drying.
- Solar drying required more area as compared to thermal drying, however the energy required is significantly less.
- Thermal drying is more controllable as compared to solar drying, however it is more expensive for implementation and O&M.

## Links to the videos

- [Sludge solar dryer](#)
- [Rotary sludge dryer](#)
- [Belt sludge dryer](#)
- [Paddle sludge dryer](#)
- [Fluidised bed sludge dryer](#)

Session

**16**

# **Mechanized Thermal Treatment**

---

## Learning objectives

In this session we will be focussing on different types of thermal treatment possible for faecal sludge and septage treatment.

We will also look at the different end products which are possible using different processes.

## Contents

- Introduction to thermal treatment and its types
- Incineration
  - Types of incineration
  - Advantages of incineration
- Pyrolysis
  - How pyrolysis is different from incineration
  - Types of pyrolysis

### 1. Introduction to Thermal Treatment & its Types

## Introduction

- Thermal treatment of sludge – energy recovery option
- Treatment process produce intermediate product which is source of energy such as Biochar & Biogas
- Nutrient recovery or energy recovery

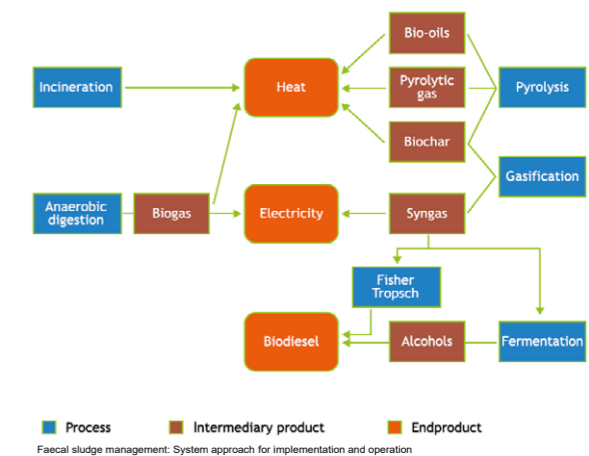

Thermal treatment of sludge can result into different types of intermediate products and end products. It depends on the process parameters and control of the process. The figure in the slide shows different kinds of processes and their products. Incineration and pyrolysis are few processes which have been tried and tested for managing faecal sludge and septage. Although there are different kinds of intermediate products possible, ultimate aim is to recover heat or generate electricity from it. In some cases, nutrient recovery is also possible.



## Emission standards

A thermal based treatment plant have to meet additional standards for emission of flue gases.

Parameter	Standard
Particulates	10 to 150 Mg/Nm <sup>3</sup>
HCl	10 to 50 Mg/Nm <sup>3</sup>
SO <sub>x</sub>	50 to 200 Mg/Nm <sup>3</sup>
NO <sub>x</sub>	100 to 400 Mg/Nm <sup>3</sup>
Hg / Pb	0.5 to 1.5 Ml/M <sup>3</sup>
CO	10 to 100 Mg/Nm <sup>3</sup>
Total Organic Carbon	5 to 20 Mg/Nm <sup>3</sup>
Gas residence time	1.5 to 2 seconds
Chimney height	30 Meters (100 Feet)

No matter which type of thermal treatment is chosen, emission standards for flue gases need to be met. The standards of discharge of these gases is shown in the table in the slide.

## 2. Incineration

### Incineration

- Complete combustion of organic matter at high temperatures
- Disposal mechanism or way to generate heat / electricity
- Reduces sludge to ash (10% of its initial volume)
- Ash as raw material for construction material

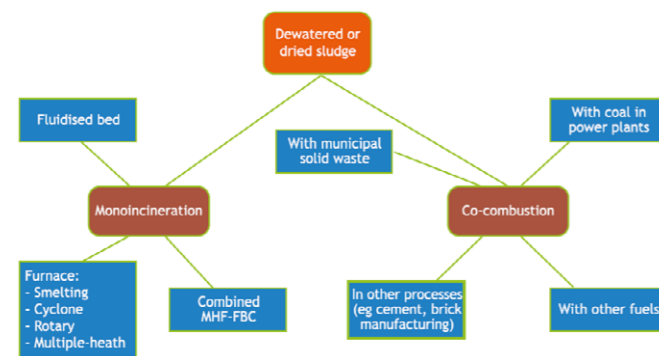

Adapted from Werther and Ogada, 1999

Incineration refers to complete combustion of organic matter at high temperatures. Thus resulting in the ash, which reduced the volume of sludge to 10% of its initial volume. Thus, incineration can be seen as a disposal mechanism for reducing the volume of end product to be disposed or to generate heat or electricity which can be used for various processes. The fly ash which is created as the end product can be used as raw material for making bricks.

Incineration of sludge can be achieved in two ways – mono-incineration and co-combustion. As the name suggest mono incineration refers to incinerating the sludge individually in different types of furnaces. Co-combustion on the other hand refers to incinerating the sludge with some other materials such as municipal solid waste, coal in power plants etc.

## Energy content

Product	Calorific value [MJ/kg]
Sewage sludge	10-29
Faecal sludge	17
Coal	26

Calorific value of faecal sludge is not as high as sewage sludge or coal

Co combustion with coal in coal fired plants or cement kilns is better

Financially sustainable only if

Cost of sludge drying for combustion < financial gains by heat extraction

Energy content in the faecal sludge and septage is quite less as compared to sewage sludge and coal. Hence, faecal sludge alone cannot replace the fuels in the furnaces. It is better to have co-combustion with coal or different fuels such as wood etc in cement and brick kilns. However, it needs to be noted that incineration is only possible when the dewatered sludge is dried with solid content of up to 60% or more. Hence financial viability needs to be checked if the cost of drying the sludge for combustion is less than the financial gains envisioned from the extracted heat.

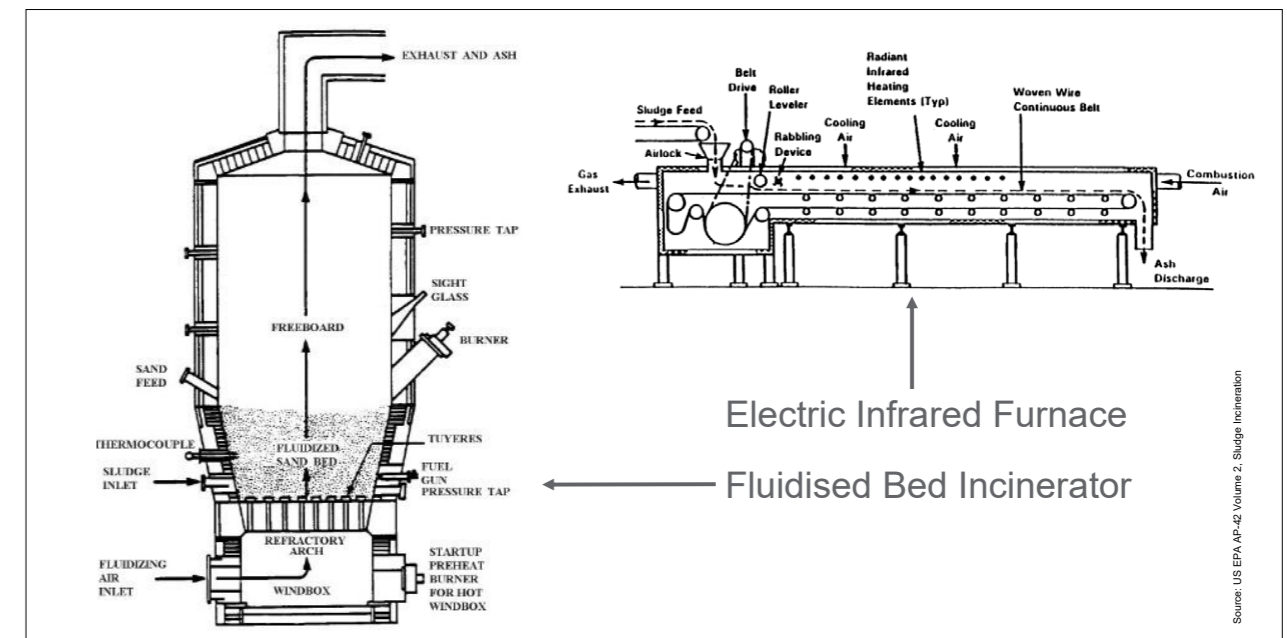

The slide shows two different types of incinerators. The one on the left side is called fluidised bed incinerator and function very similar to fluidised bed dryer, however in this case the temperature are high enough to combust the incoming sludge completely. The other figure is that of electric infrared furnace which uses electrical energy to create heat using infrared heating element. The air is heated with the infrared rays and the hot dry air absorbs the moisture and exits the furnace.

## Emissions

- Gas treatment for removal of pollutants prior to off gasing.
- NO<sub>x</sub> emissions and dioxins and furans emission are lower in sludge incineration as compared to coal and solid waste incineration respectively

(Werther and Ogada, 1999).

- Advantages of co combustion (Taruya et. al., 2002)

- Reduces NO<sub>x</sub> from cement kiln by 40%
- Reduces CO<sub>2</sub> emissions as compared to when only sludge is incinerate

Gas treatment needs to be provided to the flue gases to remove the pollutants before they are discharged into the environment. It has been researched and proved that NO<sub>x</sub>, dioxins and furan emissions are lower in cases of sludge incineration as compared to coal and solid waste incineration. It has also been proved that co combustion of sludge at cement kilns reduces the NO<sub>x</sub> and carbon dioxide emissions significantly.

However, without introduction of regulations and strict monitoring of the discharge from the industries, acceptability towards using sludge for co combustion will not be much.

## Energy produced

$$E_{p,i} = (1 - C_i) \times CV \times \epsilon$$

Where;

E<sub>p,i</sub> = energy produced by incineration (per kg wet solids)

C<sub>i</sub> = water content of the sludge

CV = calorific value of sludge (MJ/kg TS) ~17.30 MJ/kg TS for faecal sludge and 12.00 MJ/kg TS for septage

ε = efficiency of the process

The above formula gives the energy produced through incineration. The typical calorific value of faecal sludge and septage is given here, however, it is highly recommended that the same is obtained by laboratory analysis. In order to make the thermal drying self-powered through incineration of the dried sludge, the energy produced through incineration should be equal to or more than the energy required for drying of solids.

## 3. Pyrolysis

### Pyrolysis

- Heating in an oxygen depleted environment
- Temperature- 200 – 500 °C
- Organic molecule is chemically altered
- Yields carbon based end products- bio char, oils and gases

#### Thermal decomposition of organic matter

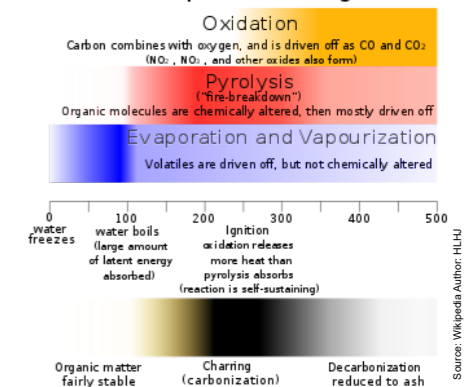

Pyrolysis refers to the stage which is intermediate to combustion. In an oxygen deficient environment and at temperature around 200 – 500 °C pyrolysis takes place. The organic molecules in the sludge are chemically altered to yield carbon based products such as biochar, oils and gases. These products can then be used as fuels for completing the combustion process.

### Dry pyrolysis

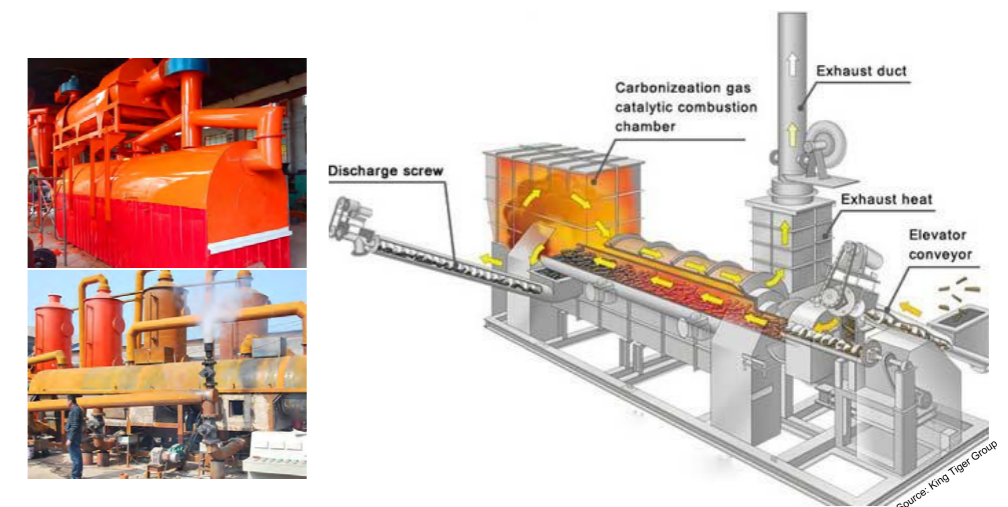

Dry pyrolysis refers to process which is taking place in dry environment. The sludge to be pyrolyzed needs to be dried to the solid content of more than 60%. This is required to avoid drop sudden drop of temperature in the pyrolyzer. The figure on the right shows the complete process from drying to pyrolysis in a skid mounted equipment. The dewatered sludge falls on the conveyor belt and is exposed to hot gases coming from the pyrolysis process. The hot air drives away the moisture and are treated before being released into the environment. The dried solids then fall into the pyrolyzer. In the pyrolyzer the dried sludge gets converted into a product called bio char which is a form of coal. The biochar is removed from the pyrolyzer using discharge screw. Thus, it can be seen that there is not physical handling of sludge involved making the complete process bio safe.

## Bio char

- Fuel in kilns and furnaces.
- Should be practiced only if production of char from wet sludge has net positive energy gain.
- Soil conditioner
- Improves water retention and aeration, however depletes nutrients



The slide shows Biochar produced at different temperatures. From the colour it is visible that the degree of carbonization increases from left to right. Production of biochar from dewatered sludge should be practiced only if there is a net energy gain is positive. Calorific value of biochar is not as high as coal and hence its acceptability as fuel is less. It can be used for co-combustion in furnace and coal powered plants. Secondary use of biochar is as a soil conditioner. Biochar is known to improve water retention capacity of the soil and aerates it. However, too much of application of biochar may also result in depletion of nutrients from plants, especially in cases where inorganic fertilisers are applied over biochar mixed soil.

## Hydro thermal carbonisation



Hydrothermal carbonisation or wet pyrolysis is also one way of tackling dewatered sludge. In this process, the dewatered sludge is subjected to high pressure and temperature by introducing steam in the reactor. Due to the control parameters, the water reaches its critical stage and chemically alters the organic carbon in the solids. Although this process is termed as ineffective carbonization, but the end product is free from pathogens and rich in nutrients. The end product of the process known as hydro char can be used as a soil supplement to improve its fertility.

## Summary

- Thermal treatment of sludge consists of incineration and pyrolysis of dewatered-dried sludge.
- The sludge needs to be dried to increase the solid content to more than 60% for incineration. Higher the solid content, better it is for combustion.
- Thermal treatment should be practiced for wet sludge only if net energy production is positive.
- These equipment do have high CAPEX and OPEX, however provides significant bio safety and reduction in the volume of end product.

## Links to the videos

- [Incineration process animation](#)
- [Dry pyrolysis process animation](#)
- [Hydrothermal carbonisation](#)

Session

**17**

# **Construction of Faecal Sludge & Septage Treatment Plant**

---

## Learning objectives

In this session we are going to focus on softer aspects pertaining to implementation of FSTP- pre construction documentation, supervision of construction, commissioning and handing over

## Contents

- Wet commissioning
- Process commissioning
- Process performance tests
- Handover documentation
- Contract documentation
- Site supervision
- Construction aspects
- Commissioning plans
- Pre commissioning tests

### 1. Contract Documentation

## Contract documentation

- Clear definition of the **duties, responsibilities** and **rights** of the parties to the contract
- Accurate **drawings** and **specifications** that provide all information needed by the contractor to carry out the work
- Supervision of the contractor's work by **experienced and knowledgeable staff**
- A contract requirement that the contractor makes **unacceptable materials and workmanship** at his own expense

Before rewarding the contract of construction of treatment facility, clear definition of the duties, responsibilities and rights of the parties should be described in the contract document. Accurate drawings and specifications of all the work needs to be mentioned. The contractor needs to go through the drawings, specification before signing the contract. Supervision of the contractor's work needs to be done by an experienced and knowledgeable staff from ULB or the consultant who prepared the DPR or the party who is responsible for O&M of the treatment plant.

## 2. Site Supervision

### Site supervision

- Appointment of an engineer/project manager
- Consultant's contract can also include the provision of the engineer and other supervisory staff
- Inputs from designers, equipment manufacturers can be included as clause under "Special Conditions of Contract"
- Defect liability period of at least 6 months and preferably 1 year
- O&M organization to be included in supervision process

Site supervision should be undertaken by a project engineer who knows the project inside out and should be involved in the project since the beginning. Ideally the project manager should be appointed from the ULB staff, however, in cases where the ULB lacks the capacity, an external consultant can also be appointed. Inputs (pertaining to installation etc) from the designer of the plant or the equipment manufacturer should be included in the job description of the project manager under the "special conditions of contract". A defect liability of at least 6 months should be provided by the manufacturer and the contractor.

## 3. Construction Aspects

### Sound construction

#### Dealing with corrosion

- Highly corrosive conditions leading to rapid rusting of steel components
- Steel components to be coated with suitable material
- Use of galvanized steel components is advisable else epoxy coating or bituminous paint
- Sulphate resistant cement in concrete and mortar for anaerobic reactors

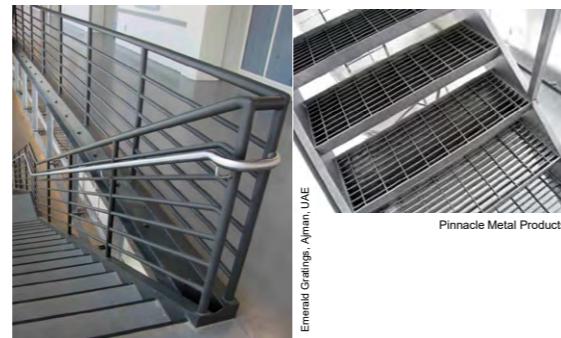

The treatment facility might have highly corrosive environment leading to rapid rusting and deterioration of the metal components. Hence, as a sound construction practice, it is recommended to use either galvanized steel components or coat the metal components with epoxy or bituminous paint. To avoid corrosion of the concrete of civil components, use of sulphate resistant cement is recommended.

### Sound construction

#### Leak free construction

- RCC tanks for water retaining structures
- Specifications should be as per the IS codes
  - Minimum spacing between the reinforcement
  - Minimum cover over the reinforcement
  - Minimum distances between the ties
- Structures should be tested for leakages



Leak free construction is primary aim during construction of waste treatment plants. Especially in cases of liquid waste treatment facility, it is of utmost importance that there is no leakage. RCC tanks should be used for water retaining structures. Specifications as per the IS codes should be followed while constructing RCC structures. The structures should be tested for leakage before wet commissioning of the treatment plant.

### Sound construction

#### Quality of concrete and other material

- Concrete mix is as specified and the material, in particular sand and cement are stored correctly
- Concrete cubes to be taken and tested for ensuring concrete quality
- Samples of material including sand, gravel and bricks to be sent for testing

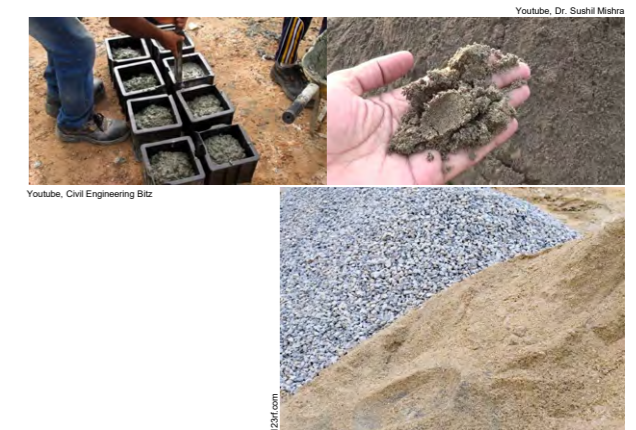

As a good practice of sound construction, concrete mix as specified by the structural consultant should be used. In cases where the concrete is prepared at the site, storage of the cement should be in correct manner on the crates in a completely dry place. It is recommended to take concrete samples in the form of cubes from each batch of concrete and send it for testing to check its strength. Samples of other material such as sand, gravel and bricks etc should be sent for testing from time to time.

Such small activities ensure that there are no malpractices happening during construction compromising the durability of the construction.

## Accurate construction



Accuracy of the construction as per the drawings is of utmost importance. As shown in the photos above, inaccurate construction may lead to operational issues. Worst case scenario is it affecting the efficiency of treatment as shown in the first and second picture.

In the first picture it is clear that sludge in certain parts of the drying bed is dewatered and dried whereas most of the other parts are still having free water. This will not only clog certain parts early but also lead to odour of nuisance of mosquitoes. In the second picture the metal v notch of the clarifier is not levelled properly. As a result of this, the water overflows only from certain portion. This will lead to creation of dead zone affecting the operational volume of the clarifier.

## Accurate construction



Some good practices are shown as accurate construction is shown in the slide. Having a splash plate at the drying bed helps to avoid displacement of sand under the inlet and ensures even distribution of sludge in the drying bed. The drying beds should have multiple inlets to avoid creation of dead zones. Use of theft proof safe covers as shown in the picture in the centre should be used. Such covers cannot be opened without specialised equipment. This also discourages theft of these metal covers which is one of the major problems in the treatment plants. U shaped vent pipes are installed on the top of the anaerobic chambers to avoid inflow of water into the reactor during rainfall or accidentally dropping something into the reacting.

## 4. Commissioning Plans

### Commissioning plan

- The contractor should prepare and submit a commissioning plan
- Roles and responsibilities of managers and/or engineers
- Plan for pre commissioning checks, wet commissioning, process commissioning and performance tests
- Gantt charts, ITPs (Inspection and Testing Plan) and ITCs (Inspection and Testing check sheet)



A commissioning plan is something which needs to be created by the contractor with the help of project manager at the end of the construction phase. This plan should contain the roles and responsibilities of different managers and engineers from the funding, engineering, supervising and O&M organization. It should contain a plan for pre commissioning checks, procedure for wet commissioning and performance tests.

Typically, a commissioning plan will have gantt charts with step by step process of inspection and testing plans and copy of inspection and testing checklists.

## 5. Pre-Commissioning Tests

### Pre commissioning tests

#### Hydrostatic testing

- Hydrostatic testing of tanks, pipes and other structures
- Hydrostatic tests are done to check strength and leaks
- Filling of structures should be done in controlled and safe manner
- Drop in pressure in pipes or drop in level in tanks indicates leaks



As a part of pre commissioning test, hydrostatic tests need to be carried out of various components of treatment plant. A hydrostatic testing helps to detect leakage in the plumbing of tanks. In this test the tanks and pipes are filled with water. In the case of tanks, the water level is marked and the level is observed after a stipulated time (24-48 hours). If there is a drop in water level, there is

a leak in the tank. In case of pipes after filling them with water pressure is applied. The pressure is observed for few hours. If there is a drop-in pressure, this means there is a leak.

If there are any leaks, they need to be detected and rectified before going ahead with wet commissioning.

## Pre commissioning tests

### Mechanical equipment tests

- Check for damage during installation
- Lubrication, clearance, end play, bearings, alignment of drives
- Trip wires, guards, safety equipment
- Valves and its position
- Prime the pumps before wet commissioning



Mechanical equipment such as pumps, motors, blowers, dewatering or drying units need to be thoroughly checked. Check should be done for any damage during installation, lubrication, clearances and alignment of drives. Earthing wires, trip wires, safety equipment etc should be checked. The on-off position of the valves needs to be checked. This needs to be done especially in case of pumps. If self-priming pumps are not used, priming needs to be done before wet commissioning.

## Pre commissioning tests

### Electrical equipment tests

- Electrical integrity test, insulation, earth leakage etc
- Voltage tests
- Trip tests
- Setting of equipment



Electrical equipment tests refer to check of electrical integrity of the circuits. Earthing, insulation and leak needs to be checked. Voltage tests needs to be done as operating the equipment on wrong voltage will face operational difficulties during wet commissioning. Trip test refers to tripping of electrical circuit in case of leak or short circuit of electricity. In such cases the circuit breaker should get activated and trip the circuits to avoid overheating of equipment.

## Pre commissioning tests

### Control equipment tests

- Completeness of installation
- Functional testing
- Calibration tests
- PLC and SCADA logic
- Check of loops, interlocks, inputs
- Simulation of fault condition

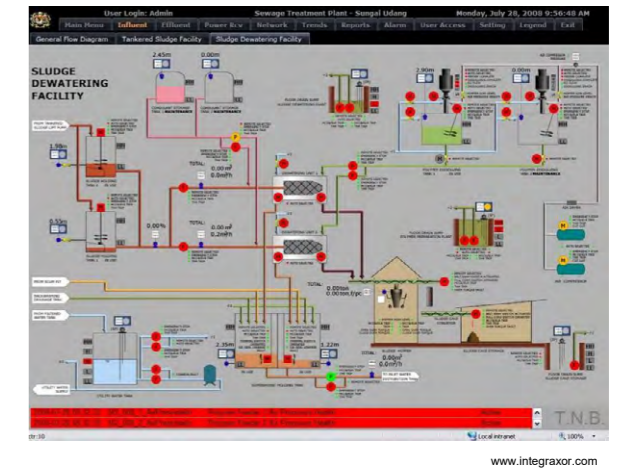

Control equipment test refer to testing of all the sensors and transmitters. Completeness of installation with respect to casing and its integrity needs to be checked. The functional testing along with calibration needs to be carried out. PLC and SCADA logic need to be theoretically checked; however, the inter-dependencies of the processes and loops etc need to check manually. Fault conditions should be simulated to check if the plant responds appropriately to the fault or not.

## 6. Wet Commissioning

### Wet commissioning

- All components of each sub system to be fully pre commissioned
- Equipment will be operated in practical limits on potable or plant service water
- Minimum duration of operation to be 48 hours

#### Items to be monitored

- Process timing and sequences
- Equipment to be operated on AUTO mode on SCADA
- Simulate all scenarios
- Check all the relevant control modes
- Response to disruption in operating mode and across full design operating range

Wet commissioning of the plant refers to the process, where in potable or service water is introduced in the treatment units and all the equipment is operated in practical limits for minimum duration of 48 hours. Strict monitoring protocol needs to be followed during wet commissioning of plants. Process timing, sequences and responses in all scenarios should be documented. In case of PLC or SCADA, all modes need to be checked. Emergency shut down scenarios should also be simulated.



## Wet commissioning

### Tasks to be performed

- Adjustment of equipment and control settings
- Operation of mechanical, electrical & control systems under process conditions
- Plant start ups and shut down testing
- Methods of isolation of equipment for safe shut down and maintenance procedures

Tasks performed during wet commissioning are as follows;

- Adjust the equipment and control settings such as the level of water in the tanks etc.
- Operate the mechanical, electrical and control systems under process conditions i.e. operational range.
- Plant start up and shut down testing should be carried out as per the process.
- In case of safe shut down or maintenance procedure, isolation of equipment and its process needs to be checked.

## 7. Process Commissioning

### Process commissioning

- Process of introducing liquid waste into the plant and establishing the biological treatment and testing
- Things to be monitored- flow, effluent quality, noise, odour, vibration, power draw
- Inputs from this needs to be integrated into SOPs and O&M manuals
- These documents should contain a list of control and instrument set points, alarm signal settings

Once the wet commissioning of the treatment facility is successful, process commissioning should be performed. During process commissioning, introduction of liquid waste into the plant is done and biological treatment process is established and physical/chemical treatment processes are tested. Flow in various components, effluent quality, odour from reactors needs to be checked. With respect to electromechanical equipment, noise, vibration and power draw needs to be checked.

As an output of the process commissioning, standard operating procedures and O&M manuals are prepared. The document should contain list of control points for instruments and sensors. Alarm signal settings needs to be explicitly mentioned for emergency shut down of the plant.

## 8. Process Performance Tests

### Process performance test

- Duration of the test- 28 days
- Aim- to demonstrate that the plant meets the output specification set out in the contract
- Things to be reported
  - Tables, graphs and calculations for interpretation of results
  - Comparison of results and guarantee requirements
  - SCADA printouts detailing any alarms and reliability of instruments
  - Discussion on overall performance of plant and its individual equipment

A process performance test is carried out for 28 days after the process commissioning is successful. The aim of this test to demonstrate that the plant meets the output specifications set out in the contract by the designer. Certain parameters need to be monitored closely during performance tests. These parameters should be tabulated and graphs should be plotted with respect to time for interpretation of results. Comparison of the results with guaranteed standards is done. SCADA output of detailing the process with alarms and responses of the instruments during the 48 hours should also be attached. The discussion over the performance of the plant and individual components such as dewatering, drying units etc should be made.

## 9. Handover Documentation

### Handover documentation

- General introduction and process overview
- Unit process guidelines
- Standard operating procedures
- Functional description and specification
- PLC and SCADA manual
- Equipment O&M manuals
- Statutory certifications
- Warranty register
- Process performance test and commissioning report
- "As Constructed" drawings
- Asset registration
- Training documentation

The handing over documents are prepared and handed over to the organization responsible for O&M of the treatment facility. The handing over documentation should contain all the individual documents listed in the slide above. These documents might change depending upon the treatment technology and its operational processes.

## Summary

- Contract documentation is important before starting the construction of the treatment facility.
- Site supervision is required for monitoring of the construction process and quality of it.
- Commissioning of treatment facility has multiple steps and might be time consuming process, however it needs to be completed before introducing the waste and handing over.
- Handing over documents is an important link between the designer – contractor and the organization performing O&M of the plant.

Session

**18**

# O & M of Faecal Sludge & Septage Treatment Plant

## Learning objective

In this session we will be looking at O&M and monitoring plans and its content for a faecal sludge and septage treatment plant.

Post this session you will be able to understand what an O&M and monitoring plan is and check its completeness before handing over.

## Contents

- Integrating O&M with Planning and Design
  - Consideration for O&M planning
  - Need of O&M plan
- O&M planning
  - Content of O&M plan
  - Asset management
- Monitoring and record keeping
  - Chain of custody

### 1. Integrating O & M with planning & designing

## O&M consideration

### Availability of local resources

- Spares and tools
- Consumables
- Human resources
- Local laboratory
- Local contracting firms

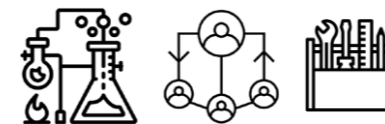

### Degree of mechanisation

- Spares, electrical power and trained operators
- Manual process v/s mechanised process
- Ex. Raking and transport of dried sludge

The slide describes the O&M consideration which need to be taken into account while designing and planning of faecal sludge and septage treatment plant.

**Availability of local resources:** Spares and tools pertaining to the natural treatment units are easily available, however, this might not be true in case of mechanised treatment units. Consumables such as polymer or hypochlorite etc needs to be bought quite frequently and hence the availability of the same needs to be checked. Skilled and trained manpower for mechanised treatment units might not be available at all places. Local NABL accredited laboratory should be identified for monthly checking of samples to maintain the records. Local contracting firms should be identified especially for preventive maintenance of various electromechanical components such as pumps and other equipment.

**Degree of mechanisation:** Mechanisation of the operations at the treatment facility reduced the human contact with the sludge and hence is required. However, higher degree of mechanisation demands, uninterrupted power supply and trainer personnel for O&M of the plant. To optimise the operations at the treatment plant having higher and continuous load of sludge should think of certain degree of mechanisation. Ex. Raking and transport of the dried sludge from the unplanted sludge drying bed can be performed using machines instead of employing manual labours.

## Receiving sludge at FSTP

**Traffic control**

- Well designed layout
- Drive through after discharge is more efficient and safe
- Mechanised unloading station for record keeping





**Approving sludge discharge**

- Waste from licensed operators
- Waste from residential and commercial properties
- Use of manifest form

Operations pertaining to receiving sludge at the facility needs to be thought about during the layout planning of the treatment facility. Especially in case of treatment facilities where higher number of trips of vehicles is expected, the layout of the plant should be well designed. In such cases, the receiving station should be located adjacent to the treatment facility or at the entrance of the plant. A drive through should be provided in such a way that vehicles do not have to reverse at receiving station. Approval and record keeping is a very important task at the receiving station and it can be time consuming too. Hence, this process can be mechanised by provided access cards to the vehicles which when tapped onto a reader fills in the details of the truck and its operator automatically. The sludge samples need to be checked before approving the vehicle to decant the vehicle. In absence of mechanisation, a manifest form needs to be filled.

<b>Sludge / septage origin</b>			<b>Excavator / transporter</b>	
Name (Household unit owner)			Operator / company	
Address			Address	
Date and time of collection			Type of vehicle	
			Plate number	
			Name of driver	
			Signature	
			Driver's license number	
			Name of other personnel	
<b>Source and volume of sludge/septage</b>				
Source	Check one	Volume (cubic metre)		
Residential				
Commercial / industrial				
Institutional				
Wastewater treatment plant				
<p>Commercial / industrial waste must be sampled and tested before it is offloaded at the treatment facility to ensure that the material will not contaminate the treatment process. Contamination can be caused by grease, oil, metals and chemicals.</p> <p>Description of commercial / industrial waste:</p> <p>_____</p> <p>_____</p>				
			<p>Approved by authorised representative</p> <p style="text-align: right;">_____</p> <p style="text-align: right;">(Name and signature)</p>	

The slide shows the manifest form to be used by the desludging operator.

## Considerations for O&M plan

**Volumes and schedules for sludge delivery**

- Type of desludging- scheduled and on demand
- Seasonal variation



**Scheduled desludging**

- O&M needs to be frequently carried out
- Part of O&M can be outsourced to specialist/experts.

**Demand desludging**



- O&M activities depend upon the operation of the plant.
- O&M plan should also consider seasonal variation

While preparing the O&M plan, the most important consideration is the type of desludging which is going to be adopted. In case of scheduled desludging the O&M tasks will have to frequently undertaken and hence in such cases, outsourcing of certain tasks such as preventive breakdown maintenance of pumps and other electro mechanical components can be done.

In case of demand desludging the O&M activities will have to be staggered depending upon the operations of the plant. Also, certain tasks pertaining to certain treatment units might decrease or increase.

## 2. O & M Planning

**O&M plan content**

- Engineering drawings and FSTP component specification 
- Manufacturer's literature and equipment operation guidelines
- Responsible person for each task 
- Frequency of each activity
- Operation procedures and tools required to perform the task
- Safety measures required 
- Information to be monitored and recorded

The O&M plan should contain the details mentioned in the slide above. The engineering drawings and specification of all the treatment components installed at the treatment facility. In the case of electromechanical components, manufacturer's details along with the literature provided with the equipment and its operation guidelines should be attached. There are different types of people who will be working at the treatment facility such as Environmental/Civil Engineer, Head operator, Operator, Chemist, Lab assistant, Skilled labour etc. The list of tasks and person responsible for it should be clearly mentioned along with its frequency.

Operation procedure and tools required to perform the task should be mentioned. Safety measure and use of appropriate PPE should be covered in the O&M plan. Information that needs to be monitored and logged into the operator's handbook should also be mentioned.

**O&M plan content**

- Chemicals and consumables
  - Quantity and quality required for operation
  - Name of the supplier and specifications

- Non regular activities
  - Name and contact details of the company
- Emergency situation
  - Steps to be followed
  - Contact details for emergencies- Fire, Hospital

O&M plan should consist of consumables such as chemicals their required quantities, name of the supplier and its specification. Storage details of these consumables should also be mentioned. In

case of non-regular activities such as overhauling of dewatering equipment. The plan should also contain the steps that need to be taken in case of emergencies such as fire or medical emergency or natural calamity.

**O&M plan content**

**Maintenance procedures**

**Preventive maintenance**

- regularly performed to reduce the likelihood of failing
- performed while the equipment is still functional so that it does not break down unexpectedly.





**Breakdown maintenance**

- repairs that are done when equipment has already broken down
- to restore the equipment to its normal operating condition

Maintenance procedures are of two types- Preventive maintenance and Breakdown maintenance.



**Preventive maintenance-** It refers to the maintenance which needs to be carried out in order to reduce the likelihood of equipment failure. It needs to be performed when the equipment is still functional so that it does not breakdown unexpectedly causing disruption of the operations. Ex. Applying grease to the moving mechanical parts to reduce the wear and tear or over heating of the equipment.

**Breakdown maintenance-** It refers to the repairs that need to be carried out to make the equipment functional after its breakdown.

**O&M plan content**

**Maintenance procedure**

- Tasks
- Frequency of actions
- Tools and supplied needed
- Step by step procedure
- Inspection

*Post maintenance activity equipment maintenance log book should be updated.*

The maintenance procedure sheets should be prepared for each treatment unit and should consist of all the information mentioned above in the slide. The list of tasks which need to be performed

for complete maintenance of the unit. The frequency of the action, certain activities such as oiling and greasing might have to be done on a weekly basis whereas checking of overhauling of the equipment needs to be done in each quarter. Tools required for performing the tasks needs to be mentioned clearly. A step by step procedure to do the task needs to be mentioned. Exactly what needs to be inspected and what does the situation means should be checked and recorded into the log book.

## TASK: CLEANING OF BAR SCREENS



- **Frequency:** After stipulated number of dumping cycle
- **Tools:** Screen raking rod and appropriate PPE Gum boots, Gloves, Helmet
- **Procedure:**
  - Stand on the raking platform. Make sure that you are comfortable and stable.
  - Use the raking rod to rake the screen- starting from the bottom to the top.
  - Push the screenings onto the slotted part of the platform and allow the water to drip back into the screen channel.
  - Once the dripping stops, push the screenings into the tipper or bin
  - Clean the raking rod with water using the water hose before storing back
  - Once the bin is full, dispose off the screenings properly.
- **Inspection:**
  - Inspect the raking rod and PPE before starting the task.



The slide gives an example of the tasks sheet prepared for maintenance of the bar screens at the FSTP.

## Other regular activities

- Cleaning of spillages (if any) at the septage receiving station
- Removal of scum layer at settling thickening tank
- Measuring the depth of sludge in settling thickening tank, digesters, drying beds.





Other activities at the faecal sludge and septage treatment plant can be cleaning of spillages at the septage receiving station. This should be done immediately after the spillage before continuing for decanting other vehicle. Removal of scum layer at the settling thickening tank needs to be carried out on a weekly basis depending upon accumulation on the scum in the tank. Measurement of the

depth of the sludge in settling thickening tank needs to be done on a daily basis or weekly basis depending on its operation cycle and incoming load of sludge. However, in the case of digesters, the measurement of the depth can be done on half yearly basis.

## Asset management

- Information of the equipment at FSTP
- Capital cost of the purchasing and installation
- Labour required for O&M
- Spare parts for repairs
- Tools and supplies
- Replacement costs





*Asset management is very crucial for smooth operation of FSTP and should be included in the O&M plan*

All the electromechanical components such as dewatering or drying equipment etc can be termed as an asset for the treatment facility and needs special attention to avoid breakdown. Asset management refers to the management of these electromechanical units. An asset management plan should contain all the information its cost and installation procedure. If any special specific spare parts which might require longer time to procure or costly should be known to the operator. The tools and supplies required to carry out the maintenance should be stored separately. Replacement cost of spares should also be indicated so that the operator can plan for the expenses in advance.

### 3. Monitoring & Record Keeping

## Monitoring

- Aim: to understand the treatment process and performance of the components of FSTP
- Requirements: planning, infrastructure (laboratory), employees and finance
- Methods
  - Visual and sensory inputs
  - Analysis and measurement at receiving station
  - Laboratory testing of samples

The aim of the monitoring at the treatment plant is to understand the treatment process and performance of the treatment units. Monitoring also serves as an early detection of any issue or failure. Monitoring plan with appropriate infrastructure, equipment in the laboratory, skilled



Such record keeping helps to trace the issues, challenges and solutions for overcoming them. This documentation becomes of utmost importance, then the operators are changed during shifts or O&M contract is awarded to the new party.

## Summary

- Considerations for O&M of the treatment facility starts from the designing and layout of the treatment facility.
- O&M plan is very important documents and needs to holistically cater to all the O&M tasks that need to be performed by the operator to keep the plant operational.
- Monitoring of the processes at the treatment facility help in early detection or completely avoid issues and challenges at the treatment facility.
- A team of people is required to run-operate & maintain the treatment facility, it cannot be run by an operator alone.

Session

19

# Siting, Layout Planning & Safety Planning of Faecal Sludge & Septage Treatment Plant



# Contents

- Siting of FSTP
  - Identification of site
  - Site selection criteria
  - Characterisation and evaluation
- Layout Planning
  - Importance of layout planning
  - Consideration of layout planning
  - Treatment component planning
- Safety planning
  - Safety measures
  - Personal Protective Equipment

## Learning objective

In this session we will understand the siting of the treatment facilities and approach for choosing appropriate location for FSTP.

We will also understand the importance of layout planning of the treatment facility and how it affects not just the aesthetic and operation but also the cost of implementation.

Lastly we are going to focus on safety planning aspects with regards to security of the plant and safety of the personnel working at the FSTP.

## 1. Siting of FSTP

### Identification of the treatment sites

#### Structured Interviews

- Desludging operators
  - Discharge sites
  - Hauling distance
  - High demand of desludging
- Municipal authorities
  - Municipality owned/reserved land
- Endusers
  - Agriculture
  - Industry
  - SWM plants
  - Hauling of the end products
  - Pricing of the end products



To identify options for treatment sites, there are a few points that one needs to take into consideration; (1) Distance of the plant, (2) Cost of land and (3) Distance for end use/disposal of the treatment products. However, the common point is that all the three considerations affects

the life cycle cost of the project. To get insights into the appropriate location for the treatment facility, structured interviews with the desludging operators, municipal authorities and end users of the treated product needs to be undertaken.

Site eligibility criteria		
Nº.	Criteria	Essential conditions
1.	Average transport distance for mechanical service provider	Acceptability and affordability for service provider
2.	Accessibility	Ease of access
3.	Surface area	Surface area > 0.3 ha
4.	Land ownership and price	Guarantee to be able to buy, at a reasonable price
5.	Neighbourhood/potential for urbanisation	Risk of future access due to urbanisation
6.	Topography	No risk of flooding
7.	Soil type	Free soil (unconsolidated)
8.	Groundwater table	> 2m deep
9.	Opportunities for disposal of treated effluent and sludge	Must have disposal and endues possibilities

General criteria drafted after referring to various site selection criteria laid down for STPs in India

The slide gives list of criteria and essential conditions for each criteria. The list has been compiled after referring to different site selection criteria laid down for siting of STPs in India. It should be noted that the criteria are not prioritised and that depending upon the situation certain criteria might weigh more important than the other.

### Characterisation and evaluation

**Further Investigation**

- Neighbourhood- nuisance
  - Bad odour
  - Appropriate distances from the residential areas
  - City development
- Neighbourhood- synergy
  - Farm lands will promote use of bio solids as well as treated water

- Soil type
  - Cost of excavation
  - Consult the local residents
- Groundwater table
  - Affects the lifetime of concrete
  - Check nearby wells
  - Consult the local residents
- Topography
  - Flooding or erosion

In order to finalise the site, characterisation and evaluation of all the possible options needs to be conducted. Hence, points such as proximity to the neighbourhood, acceptance as well as proximity to the farmlands where the biosolids and treated water can be safely reused. Soil type and characteristic of the strata at the site affects the construction cost. A rocky strata or soft strata is unfavourable as it increases the cost of structural components in the capital cost of the project. Since most of the tanks are located underground at the treatment facility, groundwater table along with its content needs to be checked. Presence of sulphates in the soil and chances of leakages and contamination needs to be assessed.

## 2. Layout Planning

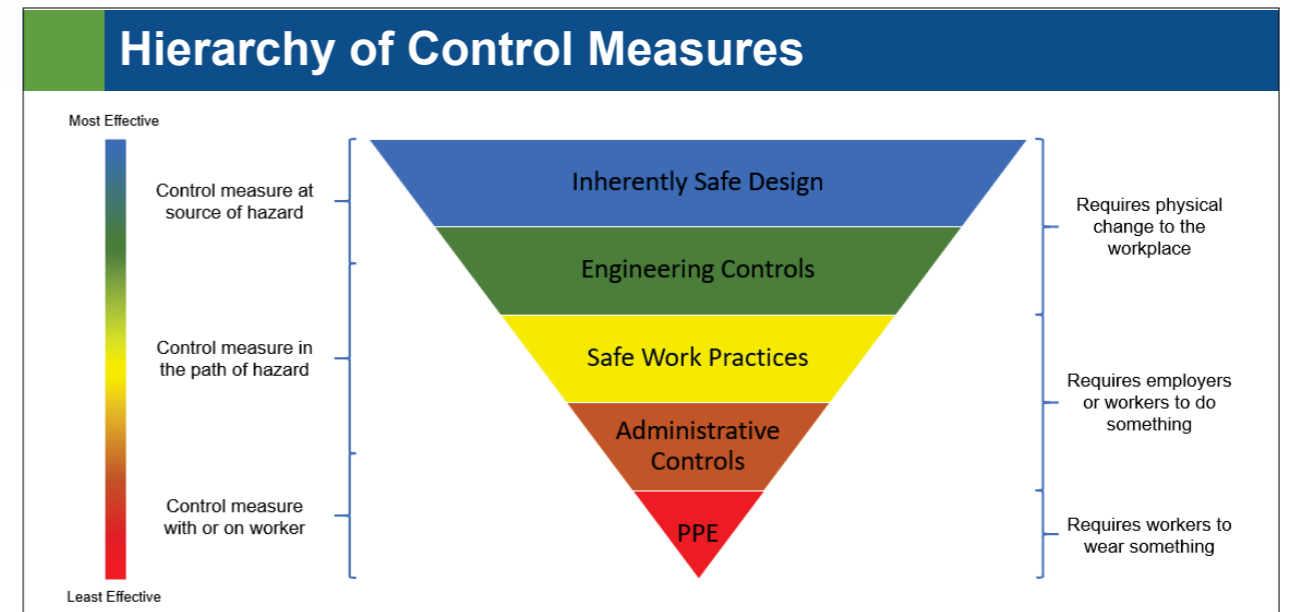

### Importance layout planning

- Site development contributes to up to 50% of the total cost of the FSTP project.
- Lack of planning results into decrease in economic feasibility of the project.
- Proper planning eases O&M tasks which ensures functionality of the FSTP

*Layout Planning impacts sustainability of the project!*

Layout planning is important as its development contributes to up to 50% of the total project cost. Cost of development of paved surfaces and green spaces at the treatment facility incurs considerable cost in the project. Hence, brainstorming to optimise the layout of the treatment facility is needed. Proper planning not only ensures smooth operations, but also eases the maintenance activities. In short, layout planning affects the sustainability of the project.

## Considerations layout planning

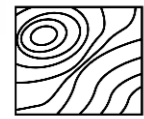

Topography

Receiving station  
Treatment units



Discharge point

To be located at the lowest point  
of the plot.

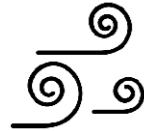

Wind direction

Receiving station  
Drying beds

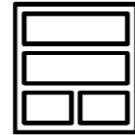

Treatment units should be  
accessible for carrying out O&M.

Consideration for layout planning are; (1) Topography, (2) Discharge point, (3) Access to treatment units and (4) wind direction. While planning the layout of the treatment facility, the advantage of the topography should be taken as much as possible. This reduces the requirement of pumping and hence reduced the operation cost significantly in the future. The storage of the treated products should be as close as possible to the discharge point. Access to treatment units such as sludge drying beds is very important for its operation and maintenance. Since these units are quite large, if not arranged well can lead to escalation in the capital cost of the project. Lastly wind direction is important in case of drying beds and solar drying beds. Also wind direction becomes important in case of open ponds or tanks where odour and vectors can be a nuisance.

## Septage receiving station



Clear access to the receiving station  
Easy manoeuvring of trucks pre and post  
decanting



No splashing / spillage during decanting

Examples of well-planned septage receiving stations.

## Screens



Inclined screens | Perforated tough | Access for operator to rake the screens



## Screens



Screen basket without adequate access



Enclosed screen with potential hazard of gases

Examples of well designed and poorly designed bar screens.

## Tanks and Ponds



Safety rails | Easy access by road / pathway | Easy access to valves and pipes



Examples of well-designed access and safety features for tanks and ponds.

## Sludge drying beds

- Access to sludge drying beds by appropriately wide roads.
- Use of hauling equipment for removing dried sludge.
- Ease of operation and maintenance tasks.
- Provision of cover for drying beds.



Sludge Drying Beds with Rain Covers

Dhawal Patil, ESF (Pune)

The slides show a good example of sludge drying bed with access to the bed from at least two adjacent sides. The paved areas around the drying beds ease the movement of hauling equipment to transport the dried sludge to the storage yard.

## Sludge Drying Beds



Importance of length to width ratio, Ease of use of equipment

The slide gives some of the good practices to be followed while planning and designing of treatment units.

## Sludge Drying Beds



Easy access to valves from outside of the bed



Use of splash plate to reduce erosion and even spreading of sludge



Use of flange joints for easy O&M tasks if needed

Dhawal Patil, ESF (Pune)

Dhawal Patil, ESF (Pune)

Dhawal Patil, ESF (Pune)

## Constructed wetlands



Constructed Wetlands with access by roads

Dhawal Patil, ESF (Pune)

Another good example of a constructed wetland having access from three sides. This allows easy movement of the vehicles and carry the gravel and sand during construction and later for operation and maintenance purposes.

## Poor access to tanks, bed and valves



The slide gives examples of poorly layout planning of the with respect to safety and O&M of the treatment units.

## Mechanical equipment

- Located inside a closed premise with ventilation
- Easy access by road and wide doorways during installation
- Space on all sides for O&M tasks
- Electrical wiring inside conduits



Source: Hydroflux, Fiji

In case of mechanical equipment, it is recommended to locate them inside the enclosed premise such as building or a shed. It should be kept in mind that there should be good access road with minimum width of 3.5 min road to the enclosure. The enclosure should have a large door so that forklifts etc can be used for installation of these equipment. Ergonomic space should be kept around all sides of the equipment so as to ease the movement of the person while performing the O&M of the equipment. Electrical wiring for the electromechanical components should be inside the plastic conduits attached to the wall.

## Sludge storage yard



- Easy access for motorised vehicles for hauling of bio solids
- Adequate area to store dried solids for couple of weeks.
- Ventilated and covered with access to sunlight
- Partitions for batches of bio solids

Sludge storage yard should have access via road with minimum width of 3.5 m. This eases the access and hauling of biosolids for use/discharge outside the plant. Adequate area should be planned so that the solids can be stored for a couple of weeks. Sludge storage yards should be well ventilated and should have transparent covers so as to allow sunlight to pass through it.

## Other components



Operator's room and Laboratory

Good access with paved road  
Plant should be visible  
Access to fresh water and electricity

Parking, Paved Roads and Storm water drains

Adequate parking with good access by wide paved road  
Provision of storm water drains

The slide shows pictures of non-treatment components in a septage treatment plant.

### 3. Safety Planning

## Safety measures

- Prevent and deter unauthorised access
  - High boundary wall with barbed wire or fences
  - CCTV cameras
- Avoid enclosed spaces where gases from anaerobic digestion might get collected
  - Wet wells
  - Pumping rooms



The slide focuses on the safety measures to be taken at the treatment plant. Fencing and compound wall should be of appropriate height. In case of mechanized treatment plant, barbed wires with CCTV cameras are also recommended. In cases of anaerobic digesters, enclosed spaces where accumulation of gases might take place should be avoided. Entry to such space should be restricted and appropriate signage should be installed.

## Safety measures

- Electrical wires should run through casing either concealed or properly clipped to the wall
- Railing, raised walls with minimum height of 1.2 m should be provided around tanks and ponds



Safety measures such as proper installation of electrical wires and fixing of rails for tanks ponds a higher storey should be practiced. The installations should be made in such a way that they are durable.

## Safety measures

- Provision of anti slip surfaces at appropriate places
  - Receiving station
  - Polymer dosing tanks
  - Dewatering equipment
- Warning notices
  - Anaerobic ponds
  - Biosolid storage
  - Treated wastewater storage



Anti-slip surfaces should be installed at the staircases and ramps. Rubber mats should be placed near the electromechanical components, where the operator will stand while operating the equipment. This eliminates the risk of electrical shocks significantly. Warning signage needs to be put up at places like ponds, storage yard and tanks. This reduces the probability of the accidents caused by ignorance of labour staff working at the plant and public visiting the plant.

## Personal Protective Equipment

### Why PPE is important?

- To avoid contact with sludge
- To prevent any injury at the plant

### When to use PPE?

- Performing day to day operations
  - Decanting the trucks
  - Raking of screens
  - Removing of dried sludge
- Performing maintenance tasks
  - Overhauling of equipments



Personal Protective Equipment (PPE) is one of the very important subjects when it comes to handling and management of waste (liquid/solid). Especially in case of FSTP where the pathogens are quite strong and sustainable, extra precautions need to be taken. Different PPEs are recommended when conducting various tasks for operation and maintenance. Examples of the same are given in the slide.

## Summary

- Siting of the plant affects the financial viability and sustainability of the project.
- Proper layout planning reduces the capital and operational expenditure significantly.
- Layout planning is also important for ease of operation and maintenance of the treatment units.
- Safety measures are of utmost importance at waste treatment facility and can be catered to by small cost.

Session

**20**

# Liquid Effluent Treatment of Faecal Sludge & Septage Treatment Plant

---

## Learning objectives

In this session we will recap the basics of wastewater treatment and extend our knowledge to the treatment of liquid effluent at the FSTP.

## Contents

- Purpose and goal of wastewater treatment
- Wastewater treatment basics
- Primary treatment
- Secondary treatment
- Tertiary treatment
- Treatment chain

### 1. Purpose & Goal of Wastewater Treatment

#### Purpose and goal

- Reduce quantity of pollutants going in to the natural environment.
- Specific purpose and goals
  - Reuse in industry (cement industry, pipe manufacturing industry)
  - To reduce eutrophication of surface water bodies
  - Reuse in the agriculture (in drought prone areas)
  - Reuse in indirect aquifer recharge

Although the ultimate aim of wastewater treatment is to reduce the quantity of pollutants entering the natural environment, in some cases the specific goals can change from case to case. Specific goals of wastewater treatment can be as follows;



- To supply water to the industry such as cement, pipe manufacturing, stone cutting or thermal power plant as process water,
- To reduce the eutrophication of the surface water bodies such as lakes,
- To reduce the dependency on the rain and irrigation canal water by reuse in agriculture in drought prone areas,
- To improve the ground water table through indirect aquifer recharge techniques.

## 2. Wastewater Treatment Basics

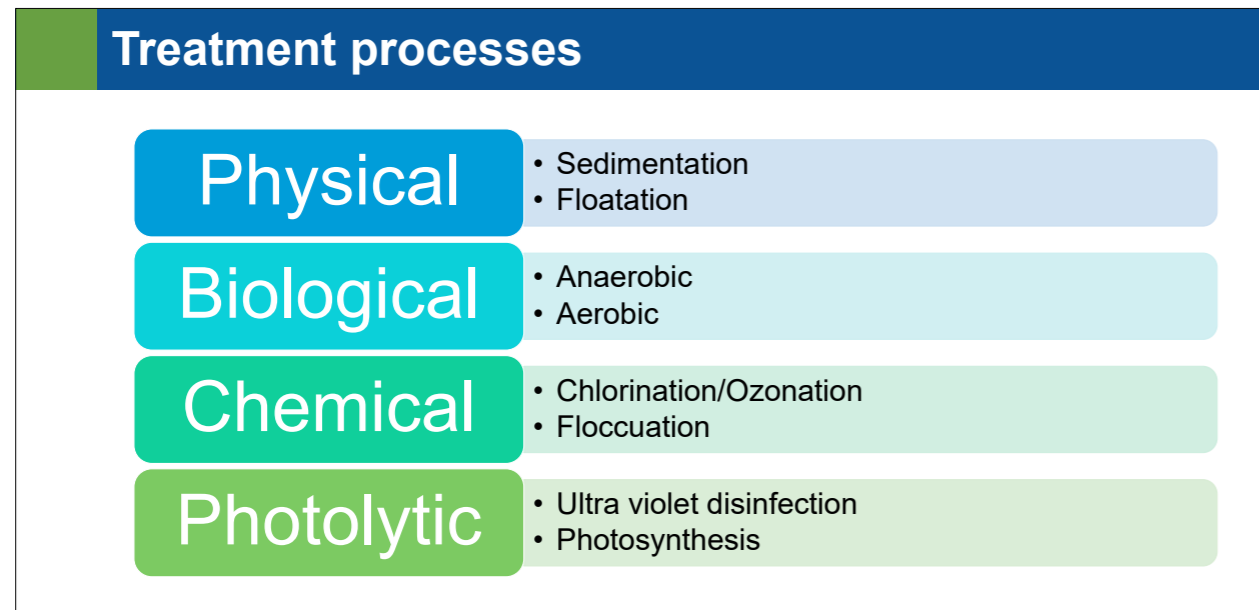

Wastewater treatment processes are of different types- Physical, Biological, Chemical and P Photolytic. Physical processes are based on the physical characteristics of the wastewater constituents. Mainly it's the specific gravity of the constituent which assists the separation from the water. Biological processes rely on the micro-organisms to carry out digestion of the organic matter in anaerobic or aerobic conditions. Biological processes are the main heart and soul of any wastewater treatment plant. Chemical processes rely on the use of chemicals to treat the water (eg. Ozonation- to kill pathogens) or to assist the physical or biological processes (eg. Alum or ferric chloride to coagulate the sludge). Photolytic processes reply on the photon in the light to treat the wastewater directly (eg. UV to kill pathogens) or indirectly (eg. Photosynthesis help to uptake the nutrients from the wastewater in case of constructed wetlands).

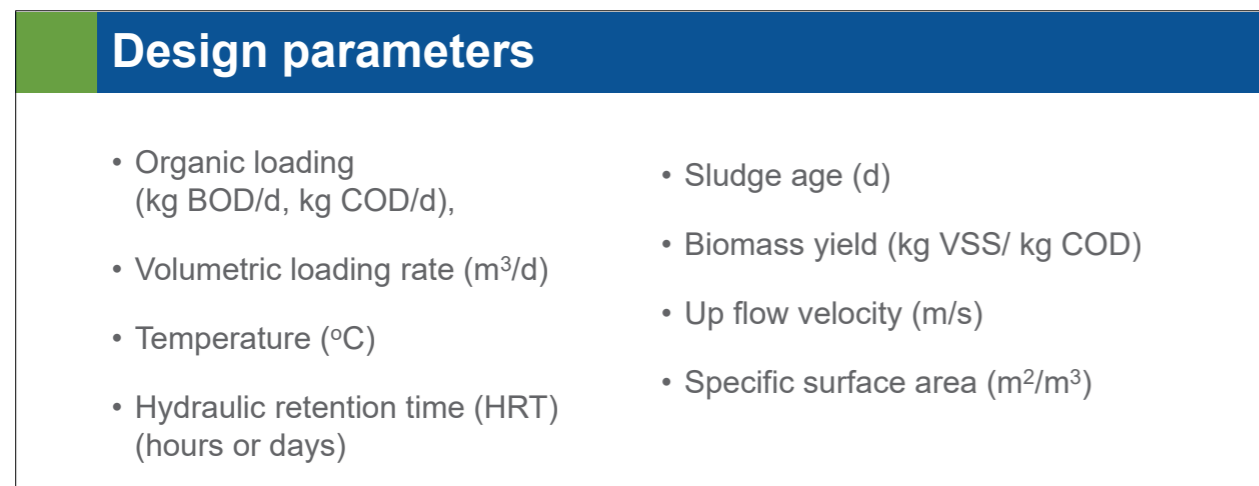

The slide shows different type of design parameters used to design wastewater treatment units. The importance of few design parameters may increase or decrease from case to case basis.

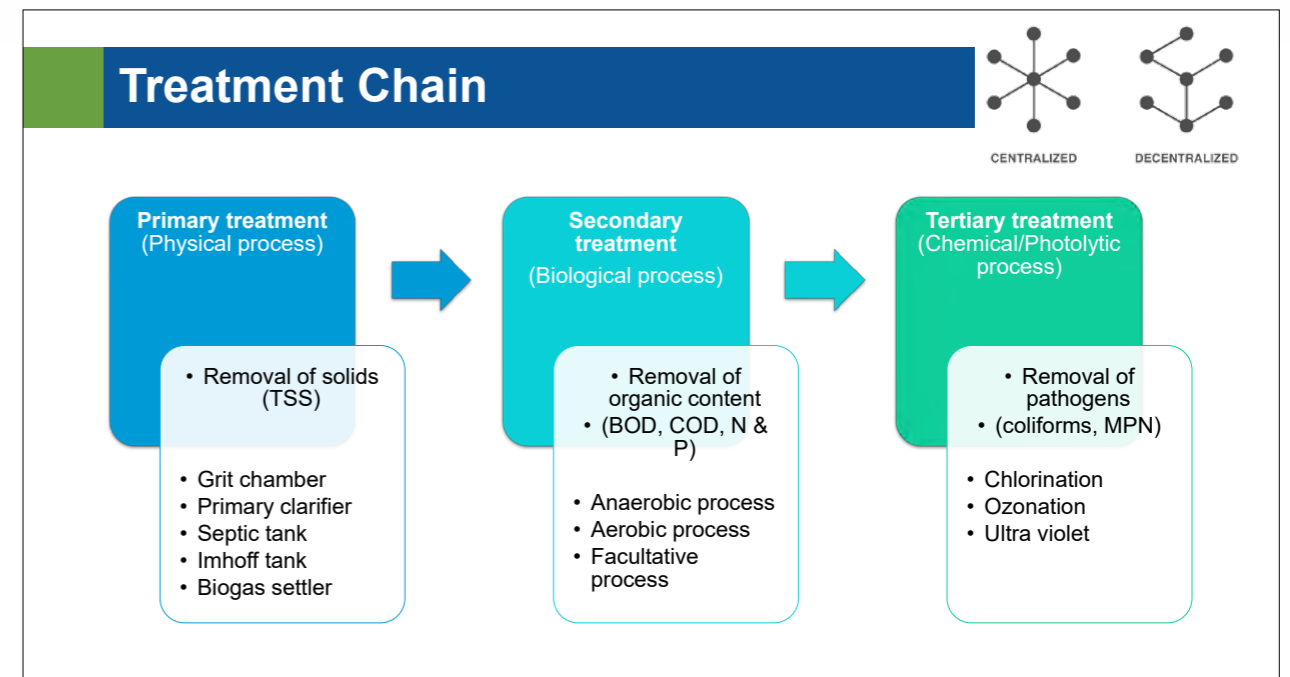

A waste treatment facility consists of different treatment stages combining different treatment processes. In the case of wastewater treatment plant, after the preliminary treatment i.e. screening; the wastewater undergoes treatment in primary stage. In primary stage, the physical treatment processes are used to remove the easily settleable solids usually known as grit. The units which provide primary treatment are listed in the slide above. In secondary stage, biological treatment processes remove the BOD and COD using the digestion process carried out by anaerobic and aerobic microorganisms. In the tertiary stage, chemical or photolytic treatment process is used to disinfect the wastewater.

## 3. Primary Treatment



Screens are used to remove the solid waste from the wastewater. Different sizes and configuration of the screens are available. Screens are either manually cleaned or mechanized to clean using a raking system as shown in the slide.



The installation of the mechanised screens is shown in the slide above. These screens are completely automated and the screenings after raking fall onto a conveyor belt which carries the solid waste and dumps it in a bin.



Grit chambers are used to remove the inert easily settleable solids. Grit chambers are available in two types as shown in the figure- longitudinal flow and circular or vortex flow. In some cases, the grit chambers are also aerated to improve the separation of solids from the wastewater. Grit chambers also remove the FOG – fat oil grease from the wastewater which is skimmed and stored separately from the grit. The mechanised grit chambers as shown in the picture also has the

provision of washing of grit before its storage. This reduced the odour from the grit and makes it easy and safe to handle.

#### 4. Secondary Treatment

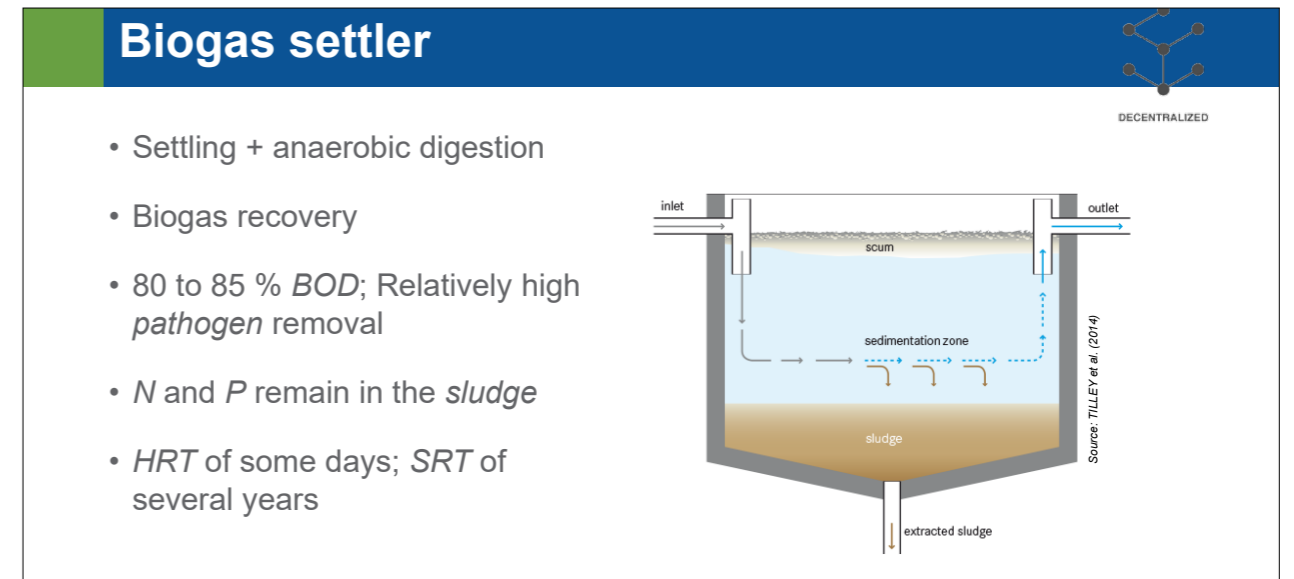

Biogas settlers are often used as a primary settling treatment and function much like septic tanks, with the difference that biogas is recovered. Wastewater and organic wastes are introduced in an airtight reactor, solids settle to the bottom, where they are decomposed by anaerobic digestion and transformed into biogas and fertilising slurry. The supernatant flows to further treatment steps or the storage tank to be reused for irrigation

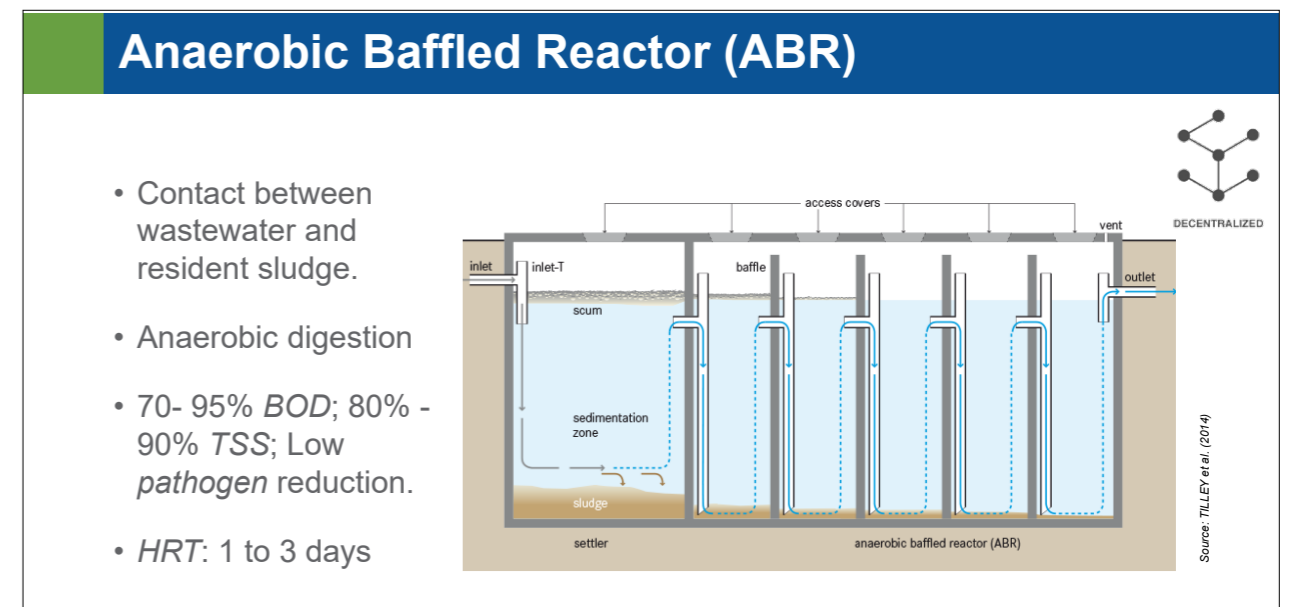

ABR is an improved version of the septic tank with multiple chambers having baffle pipes. Vertical baffles in the tank force the pre-settled wastewater to flow under and over the baffles guaranteeing contact between wastewater and resident sludge and allowing an enhanced anaerobic digestion of suspended and dissolved solids; at least 1 sedimentation chamber and 2-5 up-flow chambers.

## Anaerobic Filter (AF)

- Attached growth filter to remove dissolved and non settleable solids.
- *BOD*: 50 to 90%; *TSS*: 50 to 80 %; *Total Coliforms*: 1 to 2 log units  
*HRT*: about 1 day

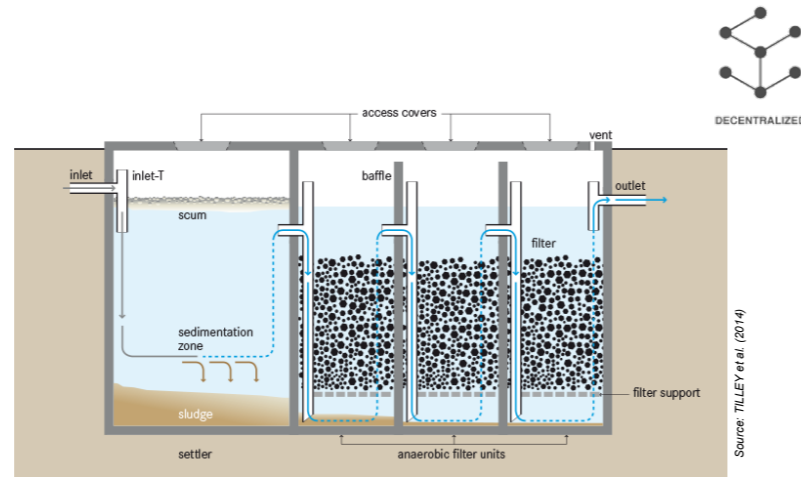

AF also consists of multiple chambers where the baffle walls or pipes force the water to the bottom of the chamber and the water flows upwards while passing through the filter. AF is based on the attached growth microorganisms. Dissolved and non-settleable solids are removed by anaerobic digestion through close contact with bacteria attached to the filter media.

## UASB reactor

- Complete anaerobic digestion. Recovery of biogas. Needs continuous and stable water flow and energy.
- 60 to 90% *BOD*; 60 to 80% *COD* and 60 to 85% *TSS*; low *pathogen* reduction minimal removal of *nutrient*.
- *HRT*: min 2 hrs, generally 4 to 20 hrs

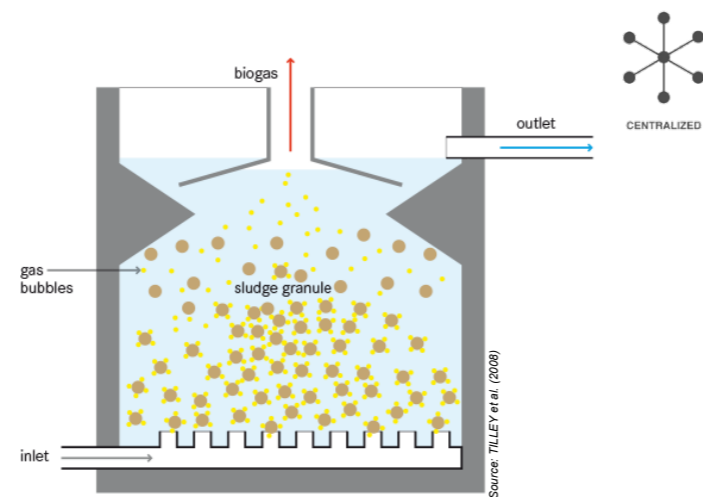

Industrial wastewater or blackwater flows into the bottom of an anaerobic upflow tank. Accumulated sludge forms granules. Micro-organisms living in the granules degrade organic pollutants by anaerobic digestion. The sludge blanket is kept in suspension by the flow regime and formed gas bubbles. A separator at the top of the reactor allows to recover biogas for energy production, nutrient effluent for agriculture and to retain the sludge in the reactor. Sludge accumulation is low (emptying is only required every few years) and the sludge is stabilised and can be used as soil fertiliser.

## Constructed wetlands (horizontal flow)

- Microbiological attachment, growths and transfer of oxygen.
- Filtration, degradation (aerobic, anaerobic, anoxic)
- *BOD* = 80 to 90 %; *TSS* = 80 to 95 %; *TN* = 15 to 40 %; *TP* = 30 to 45 %; *FC* ≤ 2 to 3 log

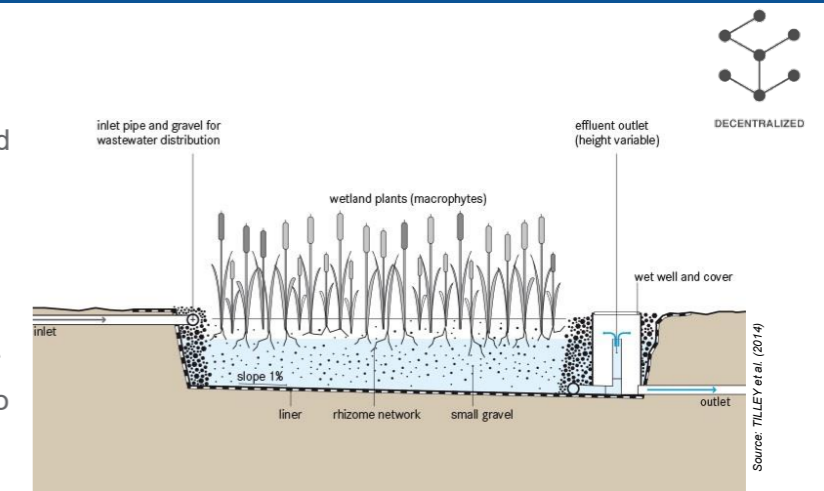

Pre-treated grey or blackwater flows continuously and horizontally through a planted filter bed. Plants provide appropriate environments for microbiological attachment, growth and transfer of oxygen to the root zone. Organic matter and suspended solids are removed by filtration and microbiological degradation in aerobic, anoxic and anaerobic conditions. Constructed wetlands can be classified based on the flow of wastewater in the bed. The picture here shows the arrangement for the horizontal flow constructed wetland. In horizontal flow type wetland, the wastewater enters into the wetland from one side and exits from the other. Hence it can be regarded as a continuous type reactor.

## Constructed wetlands (vertical flow)

- Unsaturated filter substrate where physical, biological processes.
- *BOD* = 75 to 90%; *TSS* = 65 to 85%; *TN* < 60%; *TP* < 35%; *FC* ≤ 2 to 3 log

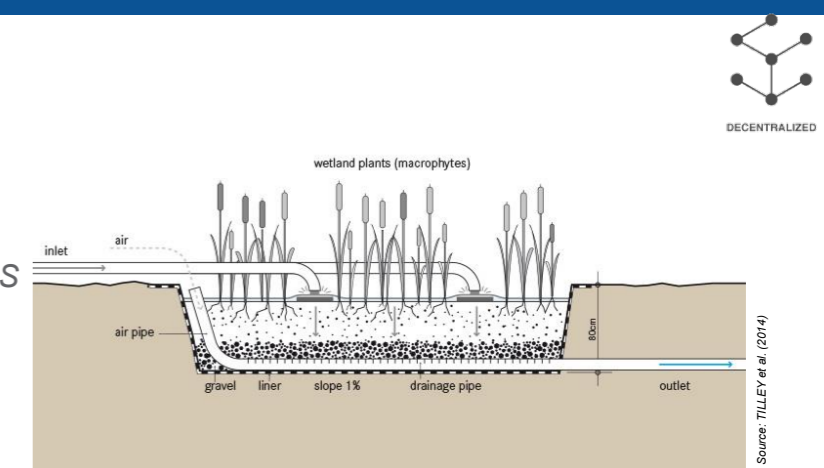

The slide here shows a vertical flow wetland. In a vertical flow wetland, the wastewater enters from the top surface of the wetland. The water percolates down and exits the system through drain pipe which also vacuums dry air from the top simultaneously. This is a batch process and there are alternate wetting and drying cycles involved.

## Activated Sludge Process (ASP)

- Suspended *flocs* of active *bacteria* is mixed with the *wastewater*.
- 80 to almost 90% *BOD* and *TSS* removal. High *nitrogen* removal. *P* accumulated in *biomass* and *sludge*. Low *pathogen* removal.
- *HRT* of some hours up to several days

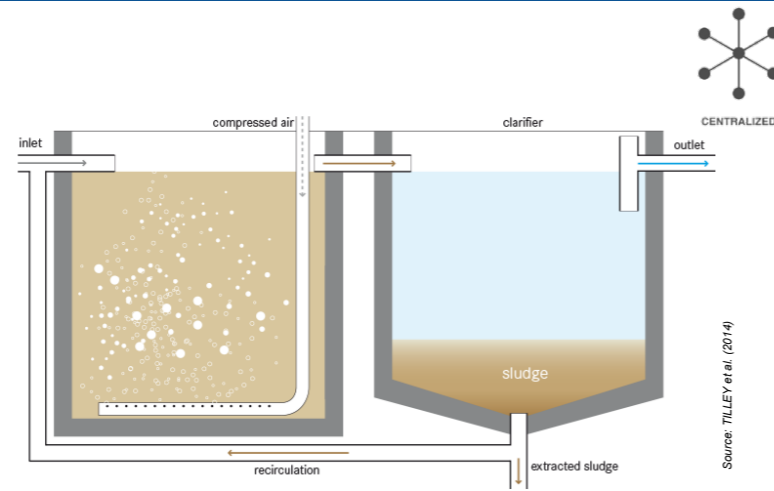

An activated sludge process wastewater containing organic matter is aerated in an aeration basin in which micro-organisms metabolize the suspended and soluble organic matter. Part of organic matter is synthesized into new cells and part is oxidized to CO<sub>2</sub> and water to derive energy. In activated sludge systems the new cells formed in the reaction are removed from the liquid stream in the form of a flocculent sludge in settling tanks. A part of this settled biomass, described as activated sludge is returned to the aeration tank and the remaining forms waste or excess sludge.

## Sequential Batch Reactor (SBR)

- Batch process consisting of four steps.
- Aerobic degradation process.
- BOD, COD and TSS removal up to 90%, nutrients and pathogen removal up to 80%

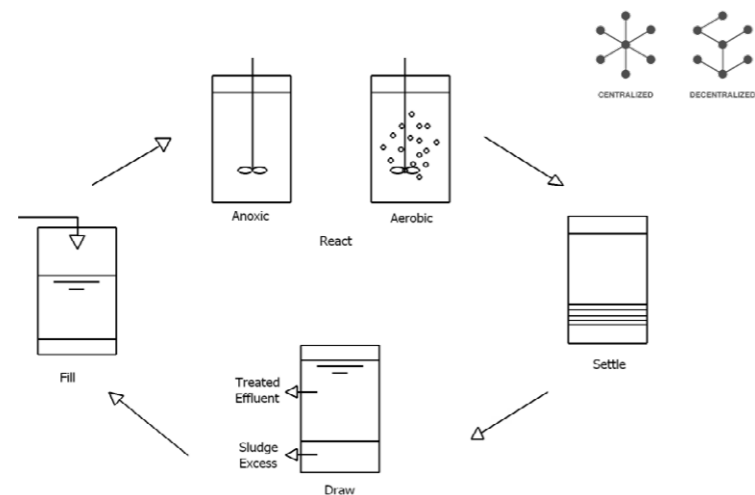

A sequencing batch reactor is a fill-and-draw activated sludge system for wastewater treatment. Oxygen is bubbled through the wastewater to reduce biochemical oxygen demand (BOD) and chemical oxygen demand (COD), producing a high-quality effluent with a low turbidity and nitrogen levels capable of meeting CPCB effluent quality standards. The SBR accomplishes equalization, aeration, and clarification in a timed sequence in a single reactor basin. By varying the operating strategy; aerobic, anaerobic, or anoxic conditions can be achieved to encourage the growth of desirable microorganisms.

## Moving Bed Bio Reactor (MBBR)

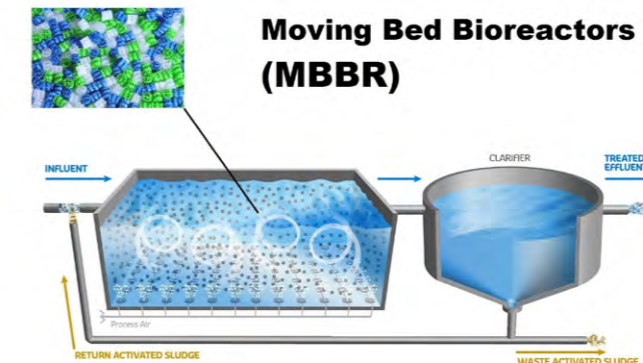

- Aerobic process
- Attached growth process
- Continuous flow process
- Use of MBBR media
- Up to 90% *BOD* and *TSS* removal. High *nitrogen* removal. *P* accumulated in *biomass* and *sludge*.

MBBR is a highly effective biological treatment process based on a combination of conventional activated sludge process and biofilm media. The MBBR process utilizes floating media within the aeration and anoxic tanks. The microorganisms consume organic material. The media provides increased surface area for the biological microorganisms to attach and grow. The increased surface area reduces the footprint of the tanks required to treat the wastewater. The treatment process can be aerobic and/or anaerobic and operates at high volume loads.

## Membrane Bio Reactor (MBR)

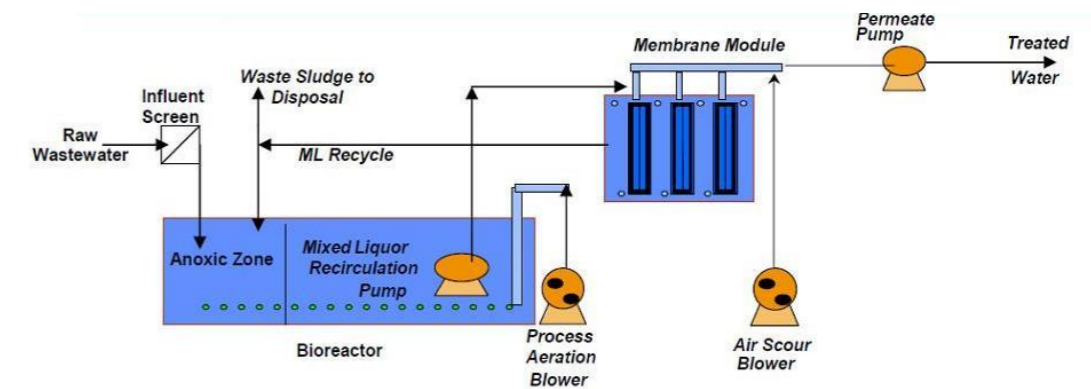

The Membrane Bioreactor or MBR is based on the conventional wastewater process, but the separation of microorganisms is performed by filtration with membranes. The MBR has some distinctive advantages compared with the conventional treatment systems: (1) very compact design, (2) high quality effluent, (3) low sludge production.

## Membrane Bio Reactor (MBR)



Source: RADJENOVIC et al. (2008)

- Biological treatment coupled with membrane filtration (physical process).
- Advanced level of organic and suspended solids removal.
- High performance BOD, COD, TSS, nutrients removal more than 90%

## 5. Tertiary Treatment

### Chlorination

- Hypochlorite solutions is diluted to make appropriate dose.
- Dose needs to be adjusted depending on the treated wastewater quality.
- Widely used as it is cheap and effective.
- Precaution needs to be taken as presence of organic matter, Fe, Mn etc leads to formation of carcinogenic compounds.
- Rapidly replaced by ozonation.



CENTRALIZED

Chlorination is by far the most common method of wastewater disinfection and is used worldwide for the disinfection of pathogens before discharge into receiving streams, rivers or oceans. Chlorine is known to be effective in destroying a variety of bacteria, viruses and protozoa, including Salmonella, Shigella and Vibrio cholera. Chlorination plays a key role in the wastewater treatment process by removing pathogens and other physical and chemical impurities. Chlorine's important benefits to wastewater treatment are listed as follows: (a) Disinfection, (b) Controlling odor and preventing septicity, (c) Aiding scum and grease removal, (d) Controlling activated sludge bulking, (e) Controlling foaming and filter flies, (f) Stabilizing waste activated sludge prior to disposal, (g) Foul air scrubbing, (h) Ammonia removal.

## Ozonation

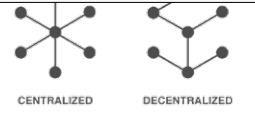

CENTRALIZED DECENTRALIZED

- Infusion of ozone.
- High tech equipment is required.
- High efficiency.
- Relatively high O&M cost.

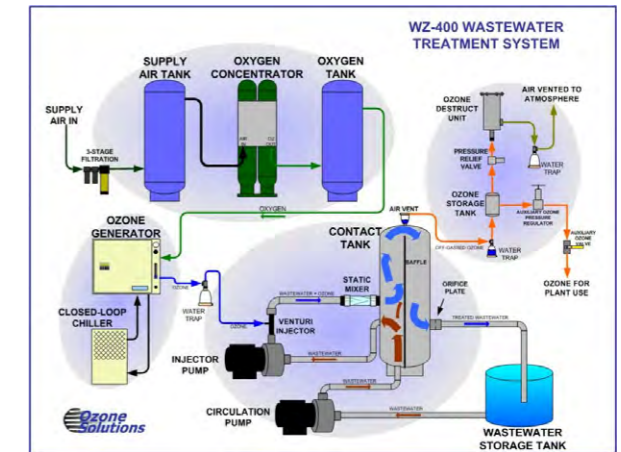

Source: THE OZMOTICS INSIDER (2008)

Disinfection of water using ozone is advantageous compared to more traditional methods, such as chlorine or UV disinfection. Ozone effectively breaks down the lipid layers in the cell membrane. Firstly, ozone is more effective at deactivating viruses and bacteria than any other disinfection treatment, while at the same time requiring very little contact time.

## 6. Treatment Chain

### Case I: ASP

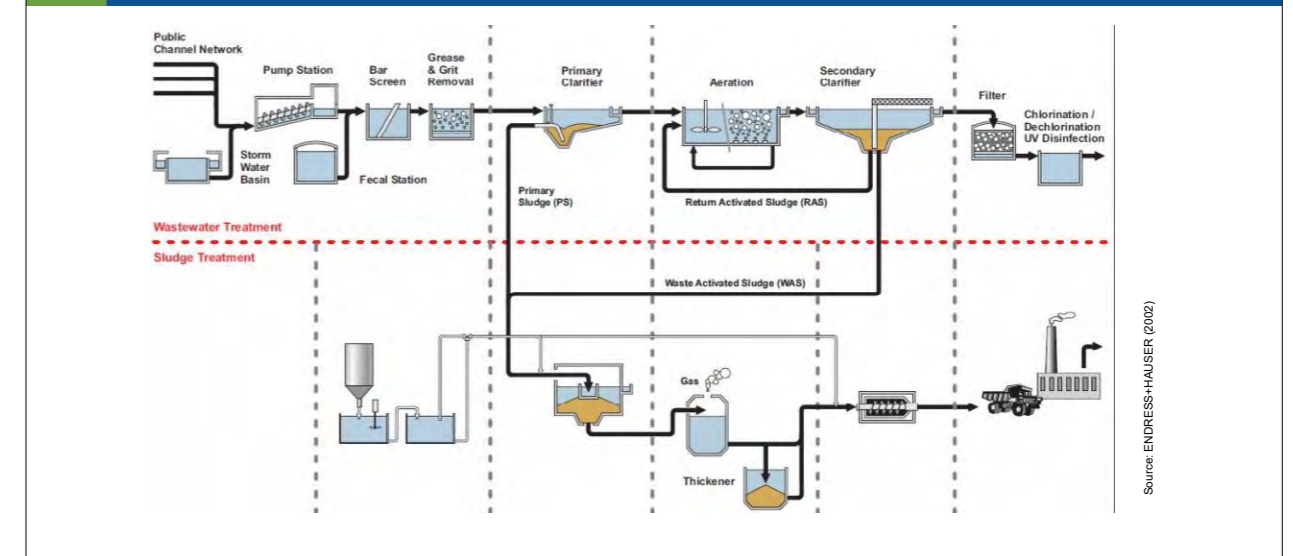

Source: ENDRESS+HAUSER (2002)

The slide represents the flow diagram for activated sludge process based sewage treatment plant. The upper part refers to the treatment of the wastewater, however, the lower half shows the treatment of sludge.

## Case II: DTS

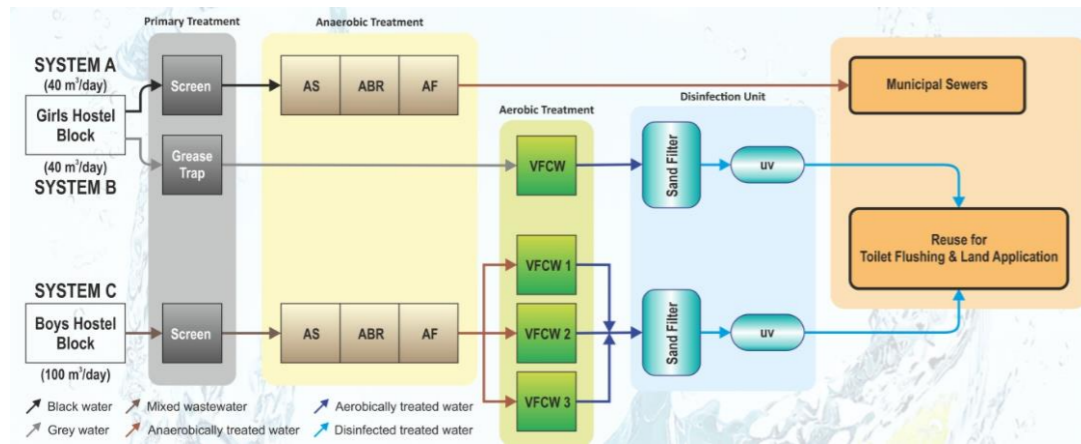

The slide here represents a decentralised wastewater treatment (DEWATS). In this case there are three smaller subsystems. The system A caters to the black water. After anaerobic treatment consisting of an anaerobic settler, anaerobic baffled reactor and anaerobic filter, the wastewater is disposed into the municipal sewers. The system B caters to grey water using a vertical flow constructed wetland. After treatment the wastewater is disinfected using dual media filter followed by UV. The system C caters to the sewage and is given anaerobic and aerobic treatment. Post disinfection the water from the system B and C is reused for toilet flushing and gardening.

## Summary

- The purpose and goal of treatment of wastewater should be clear before considering different options for treatment.
- Wastewater treatment technologies consist of different components whose design needs to be individually tweaked for liquid effluent from FSTP.
- Nitrification, denitrification and aerobic treatment is needed order to achieve standards of treatment.

## Case III: DTS

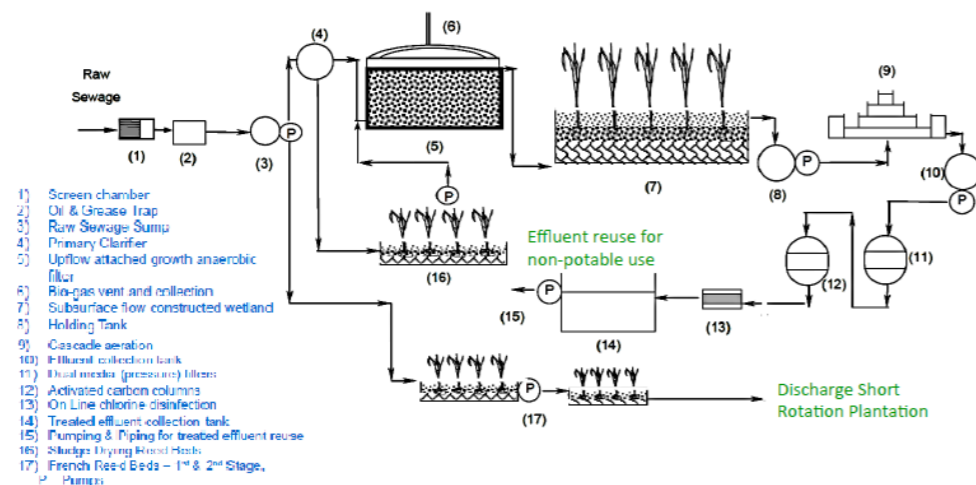

The slide represents another decentralised wastewater treatment of design capacity 100 KLD based on anaerobic upflow growth reactor and French reed bed system for treating the raw sewage directly. The treatment of the sludge produced in the anaerobic treatment was treated using planted drying beds. A decentralised wastewater treatment system hence can be mechanised with pumps, blowers etc and does not essentially mean DEWATS which is essentially completely natural without requiring electricity for treatment.

Session

**21**

# **Financial Aspects of Faecal Sludge & Septage Management**

---

## Learning objective

In this session we will take a look at different financial aspects regards to infrastructure project such as setting up a FSTP.

We will also look into different finance and contract models for operating FSSM citywide.

## Contents

- Financial aspects
  - Capital expenditure
  - Operational expenditure
  - Income and revenue
  - Annualized cost
- Financial transfers
- Financial flow models
  - Discrete model
  - Integrated model
  - Sanitation tax model
  - License model
  - Incentivised model

### 1. Financial Aspects

## Capital expenditure

- Cost of land & site preparation
- Civil structures (life span of 30 years)
- Plumbing and electrical component (life span of 15 years)
- Electromechanical components (life span of 10 years)
- Planning and supervision cost
- Cost for site investigation and sampling
- Transport and overheads

Capital expenditure refers to all the one-time expenditure done to set up the treatment facility such as a FSTP. It generally includes all the costs listed on the slide. The percentage contribution of each component here changes depending upon the selection of treatment modules. For example; in case of treatment using settling thickening tank, sludge drying beds and DEWATS, the cost of



civil cost will contribute largely to the total cost of the project. However, in case of mechanised dewatering and drying, the cost of electromechanical components will be on the higher side. The planning and supervision cost also increase in the same proportion when the civil components increase. Since civil construction takes considerable time, planning and supervision cost also goes high in that case.

## Operational expenditure

- Direct costs
  - Expenditure to be borne in treating the faecal sludge and septage received at the treatment plant.
  - Cost of material for operation
  - Cost of power for operation
  - Cost of chemicals (if required any)
- Indirect costs
  - Expenditure to be borne even if faecal sludge and septage is not received at the treatment plant.
  - Human resource cost

Operational expenditure is referred to the cost required to operate the treatment plant to treat and manage the sludge at the FSTP. This cost can be divided into two heads- direct and indirect cost. The direct cost refers to the cost which needs to be borne for actual operation and will vary depending upon the quantity of sludge received at the FSTP. Indirect cost on the other hand refers to the cost to be borne irrespective of the quantity of sludge received at the plant. Example is human resource cost and lease (in case the land is procured on lease for constructing FSTP).

## Income and revenue

- Discharge fee
  - Fee collected from the collection and transport company to discharge faecal sludge and septage at the treatment plant.
- Purchase price
  - Revenue generated from the sell of end products such as soil conditioner, solid / liquid fuel, building material etc.
- Budget support
  - Financial support provided by the government authority (ULB) to the company operating and maintaining the treatment plant.

There are various streams of income and revenue for a FSTP. Standard streams are listed on the slide. Discharge fees refers to the tipping fee to be given by the desludging operator to the FSTP operator for taking the responsibility of the sludge for treatment and further disposal. Purchase price refers to the revenue generated by sale of the treated products. However, it needs to be understood that from these two streams, it is impossible to meet all the operational expenditure

of the FSTP and hence budget support is needed. Budget support refers to the financial support provided by the government authority to the company which is operating and maintaining the plant.

## Annualized cost

$$\text{Annualized Cost} = \text{CapEx} \times \frac{(1+r)^N \times r}{(1+r)^N - 1}$$

$$\text{Annualized Cost} = \text{Annual CapEx} + \text{OpEx} - R$$

Where;  
 CapEx: Capital expenditure  
 r: Rate of interest (bank rate – inflation rate)  
 N: life span of the component

Where;  
 OpEx: Operational expenditure  
 R: Revenue

Annualised cost method is one method of life cycle analysis of infrastructure projects such as treatment plants. This method aggregates operation-maintenance cost, income and revenue and capital expenditure of the project into one single cost. It factors in the life of the civil, electromechanical and plumbing and electrical components based on their life spans. The O&M cost is factored in using rate of interest. Hence the method annualizes all the cost a given one cost which can be compared for all the technologies to choose suitable technology.

## Cost analysis of FSTPs in India

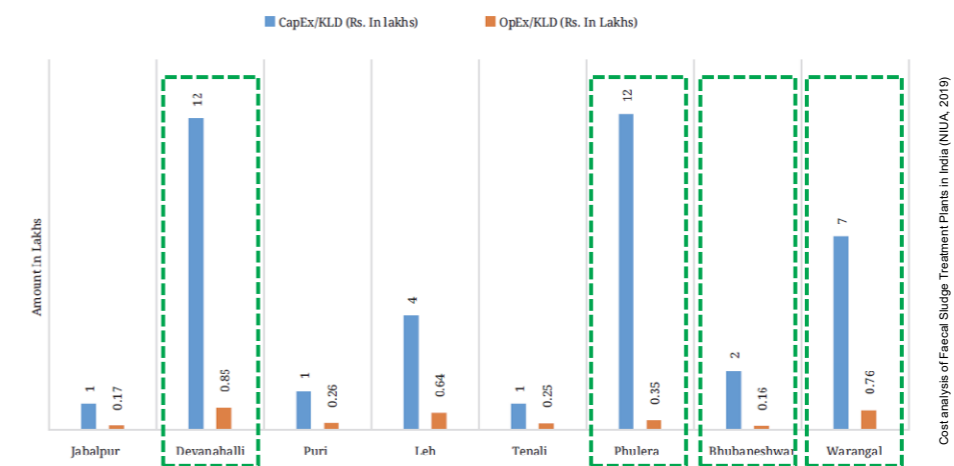

The slide gives cost analysis of the FSTPs in India. The plants marked in green are the plants which cater to both liquid and solid treatment completely. The blue bar shows the capital cost of the technology whereas the orange bar gives the O&M cost of the technology. Devanahalli and Phulera plant is based on DEWATS module, with feeding tank, stabilization unit, unplanted

drying beds and co composting for solids treatment whereas for liquid treatment AS, ABR, AF and PGF have been installed. Bhubaneswar is also based on DEWATS model, however, here settling thickening tank is used for separation of solids and liquid. At Warangal the treatment units are screw press followed by thermal drying and pyrolysis of the sludge. Liquid after dewatering is also treated separately.

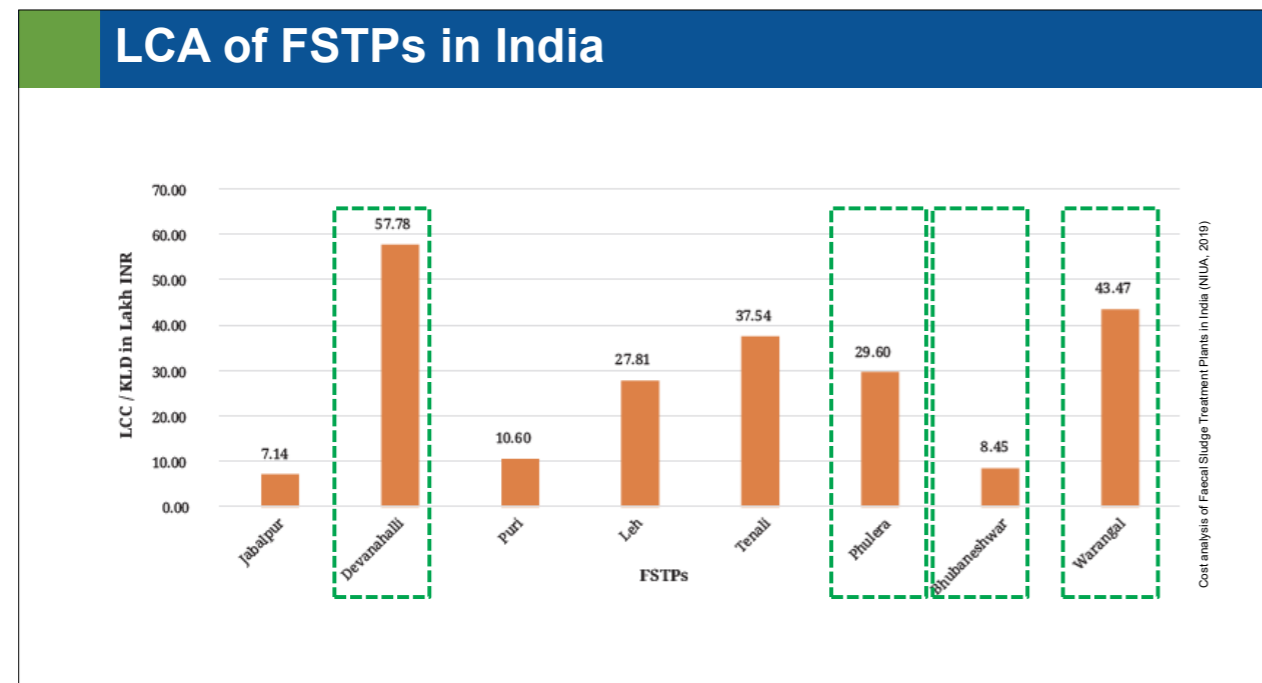

The life cycle cost of these plants is shown in the slide above. It can be observed that cost of Bhubaneswar plant is far less as compared to the other three plants. Hence it can be seen that appropriate selection of the treatment units is necessary for optimising the cost of treatment. In LCA, the design capacity of the treatment plant can have an impact on the life cycle cost. The design capacity of each plant are as follows; (1) Devanahalli- 6 KLD, (2) Warangal- 15 KLD, (3) Phulera- 20 KLD, (4) Bhubaneswar- 75 KLD. Thus, it is also important to explore other options to manage septage for smaller capacities instead of having a full scale FSTP.

## 2. Desludging and Financial Flow Models

### Demand desludging

Customers call the service provider directly to request for service

Service may be performed by public or private operator

**Advantage**

- Provides the households more control over their facility as they determine when to request for service
- No requirement of database of septic tanks for MIS and collection of sanitation tax

**Disadvantages**

- Containment may be full before the request for service
- Lump sum payment at the time of service
- Expensive as the process is time consuming
- No opportunities for optimisation of the service
- No guarantee of income/month for the operators

**Demand Desludging** – Currently in India ULBs are practicing demand desludging. The provision of desludging services upon request by the household is called demand or “on demand” desludging. The household can opt for calling a private operator or the ULB for availing this service. Demand desludging has more disadvantages as compared to advantages.

Disadvantages:

- Usually the households call for the service only when there is an emergency such as back flow from the septic tank or stinking odour from the toilets. This essentially means that the containment system is full (more than a year ago or so) well before the service has been called for. Thus, increasing the pollution load on the water bodies where the sullage is disposed.
- The charges for the desludging service are fixed by the private operator based on the ground conditions. These charges can be usually high depending on how worse the situation is. In case of ULBs, the charges are usually fixed and quite affordable but the service is not prompt and hence households do not opt for this option.
- The process of desludging is time consuming as the scum on the top has hardened and needs to be loosened and broken-down using jetting machine. Once the scum is broken down, the contents of the septic tank are mixed well using jetting machine or rods and vacuumed out of the septic tank into the truck. However, the solid content in such cases are quite high and hence the vacuum pump cannot work in optimal range of vacuum and is inefficient.
- Since the call for service can come from any part of the town and households located at varying distances from the treatment/disposal point, there is not scope for optimisation of service making it more expensive.
- Since there is guarantee of income per month for the operators, this discourages the private enterprises from entering into this business. Moreover, the existing operators might tend to charge more in absence of proper regulations.

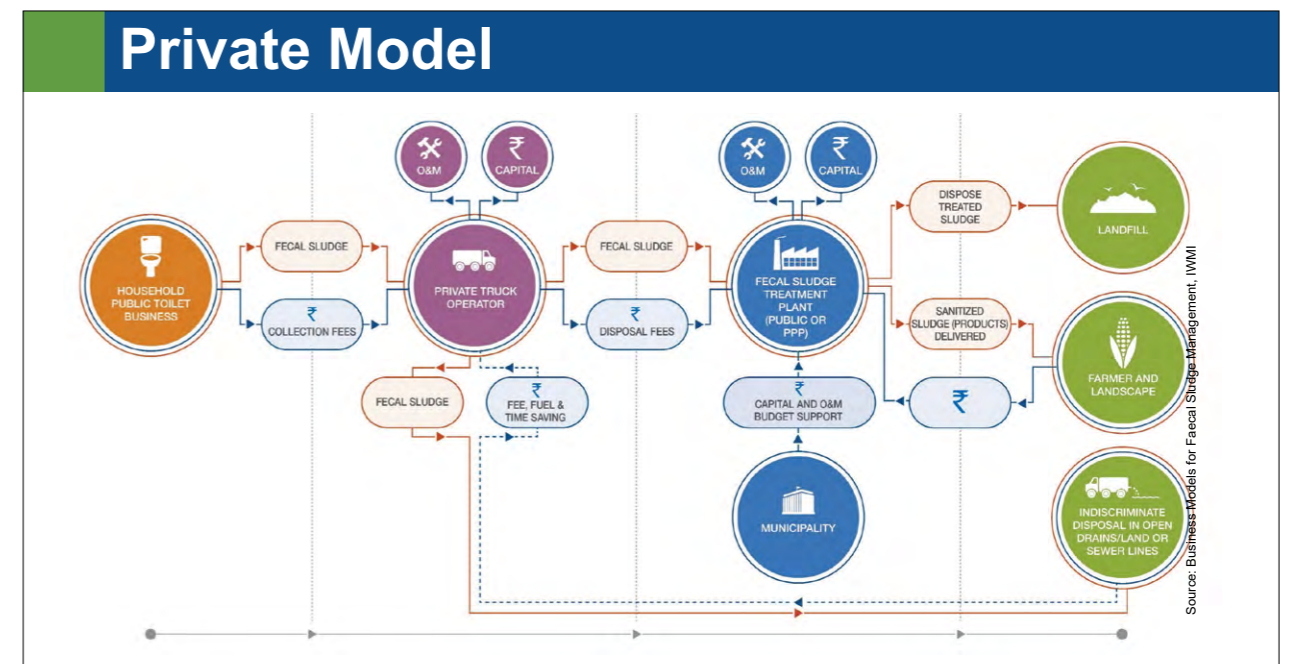

In a commonly occurring scenario, when an emptying activity is initiated by a private enterprise (mechanical or manual emptying), the households or customers with on-site sanitation systems can contact the private operator to provide emptying services on a fixed agreed tariff. Ideally, the private operator is required to transport and safely dispose the FS either to a treatment plant or to a designated disposal site, typically a landfill. In the first case, there is an FSTP which is constructed and managed by municipal authority or its on PPP model and private operator is

transporting the FSS to the FSTP. In the second scenario, as there is no binding to private operator with municipal authority, they can opt the indiscriminate disposal of it on landfill site or water bodies or in open drains.

FINANCIAL IMPLICATIONS	REGULATORY AND MONITORING IMPLICATIONS
Benefits for emptying operations (N) Reduces emptying cost to households (P) Requires subsidy (N) Improve cost recovery of FSSM (N)	Requires close monitoring for regulatory compliance (Y) Modification of sanitation codes and policy (N)
INSTITUTIONAL IMPLICATIONS	ENVIRONMENTAL AND HEALTH IMPLICATIONS
Requires public sector involvement (P) Requires private sector involvement (Y)	Reduces indiscriminate disposal of sludge (N) Concerns of public health and environmental safety (Y)
Y – Yes, P – Possible, N – No, NA – Not applicable	

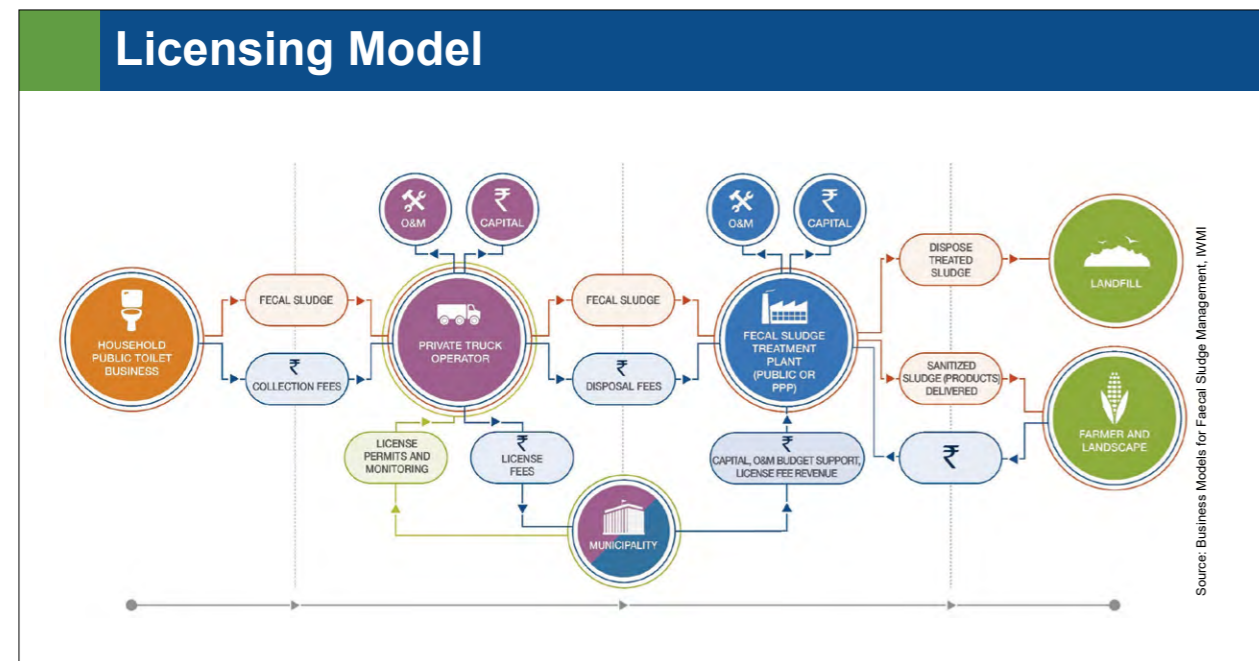

This model is similar to the commonly occurring private emptying and transportation model. The key difference lies in the issuing of license/permits to the private truck operators by relevant municipal authorities to operate emptying activity. Licensing helps in accounting for all emptying activity in the city, and can potentially track these operations to prevent illegal disposal of FSS. The license/permit could be either a one-time fee or fees paid annually by the truck operators. The municipal authority issuing the license provides basic “dos and don’ts” to the truck operators, and they need to monitor for regulatory compliance by tracking the operations of private truck operators. The license is revoked, if the truck operator is found to be violating any regulations, especially engaging in the illegal disposal of FSS in non-designated sites.

FINANCIAL IMPLICATIONS	REGULATORY AND MONITORING IMPLICATIONS
Benefits for emptying operations (N) Reduces emptying cost to households (P) Requires subsidy (P) Improve cost recovery of FSSM (N)	Requires close monitoring for regulatory compliance (Y) Modification of sanitation codes and policy (Y)
INSTITUTIONAL IMPLICATIONS	ENVIRONMENTAL AND HEALTH IMPLICATIONS
Requires public sector involvement (Y) Requires private sector involvement (Y)	Reduces indiscriminate disposal of sludge (Y) Concerns of public health and environmental safety (N)
Y – Yes, P – Possible, N – No, NA – Not applicable	

### Scheduled desludging

- Regular and periodic emptying service provided to the household
- Zone by zone desludging
- Financial management with ULB

#### Challenges

- Requires a strong IEC and BCC.
- Difficult to be practiced in ULBs with low tax collection efficiency.
- Different sludge accumulation rates and FS storage capacities makes estimation of “optimal frequency” difficult

#### Advantages

- Ensure the performance efficiency of septic tank
- Helps to preserve environmental health
- Avoids emergency situation- preventive measure
- Cost effective through program efficiency
- More affordable as the payments are spread out over time

Scheduled desludging is a concept where the containment units are emptied at a fixed frequency decided by the ULB. The households need to be informed in advance regarding the service time. Financial management are to be done by ULB. The advantage of practicing scheduled desludging is that it helps the septic tank to perform consistently. Since the scum is still soft, the desludging process is quite easy and requires less time. The cost of desludging can be brought down by optimising the route. Since the cost of desludging reduces, it becomes more affordable to the households.

Although, there are advantages, scheduled desludging does face some challenges. Operationalising scheduled desludging requires a strong IEC campaign. If the desludging charges are to be recovered in the form of tax, then the ULB should focus of increasing and maintaining the tax collection efficiency. In this case, ICT can be used for improving the performance. Since the sizes of the tank and sludge accumulation rates can differ, the optimal frequency of the desludging cannot be gauged easily.

## Sanitation Tax Model

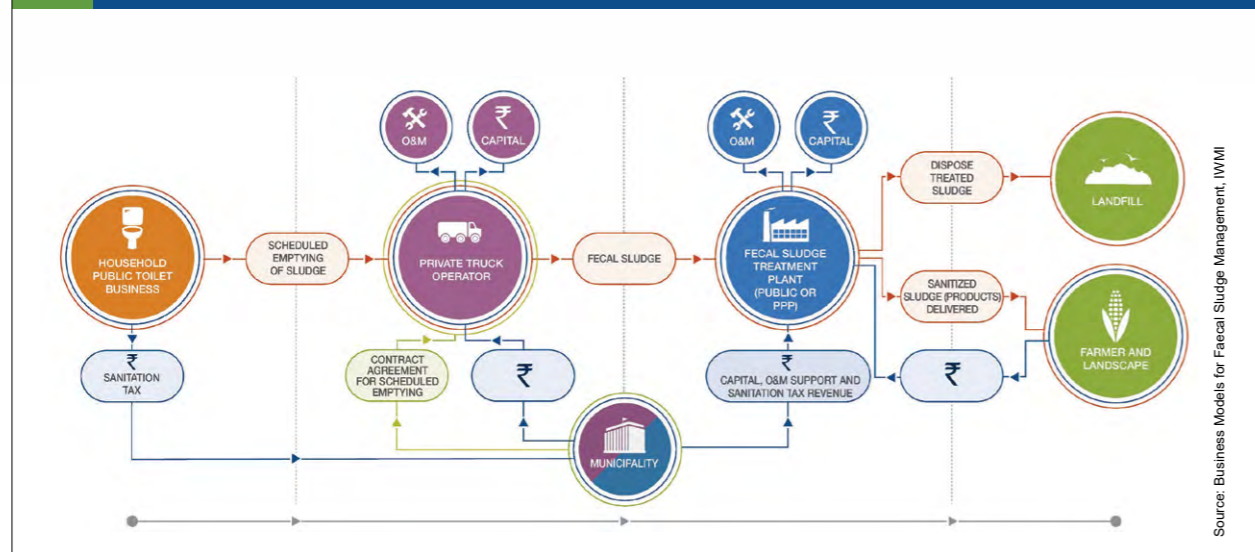

This model has two key aspects: a) sanitation tax collected from owners of OSSs, and b) mandatory scheduled desludging of tanks/pits. Sanitation tax is collected by the local municipal authority either as a percentage of property tax or by the public utilities as a surcharge on water bills. Local authorities in discussion with the households using OSSs set up a mandatory scheduled desludging plan. The user of the OSS does not pay for the desludging services unless they require an unscheduled service. The revenue generated from the sanitation tax is designed to cover the O&M cost of collection, transportation and treatment of FS. Local authorities can contract scheduled desludging to private truck operators to collect and transport sludge to designated disposal or treatment sites. The private entity receives payment based on the quantity of sludge delivered to the treatment plant (preventing illegal dumping) and the number of households that used the desludging service.

FINANCIAL IMPLICATIONS	REGULATORY AND MONITORING IMPLICATIONS
Benefits for emptying operations (P) Reduces emptying cost to households (P) Requires subsidy (P) Improve cost recovery of FSSM (P)	Requires close monitoring for regulatory compliance (Y) Modification of sanitation codes and policy (Y)
INSTITUTIONAL IMPLICATIONS	ENVIRONMENTAL AND HEALTH IMPLICATIONS
Requires public sector involvement (Y) Requires private sector involvement (P)	Reduces indiscriminate disposal of sludge (Y) Concerns of public health and environmental safety (N)
Y – Yes, P – Possible, N – No, NA – Not applicable	

## Incentivized Disposal Model

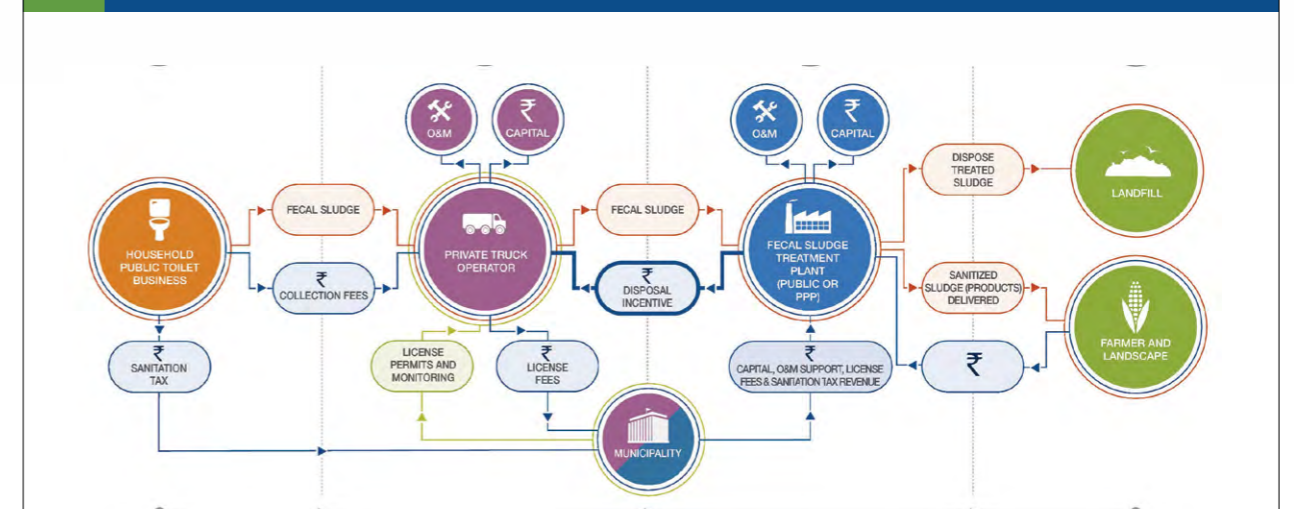

This model provides financial incentives to truck operators to encourage disposal of sludge at designated treatment sites. The objective of the model is to eliminate

indiscriminate disposal of FS. The model does not charge disposal fees to truck operators to discharge FS at treatment sites, and instead the truck operators are paid a fixed price by the treatment plant for delivering FS.

FINANCIAL IMPLICATIONS	REGULATORY AND MONITORING IMPLICATIONS
Benefits for emptying operations (Y) Reduces emptying cost to households (N) Requires subsidy (Y) Improve cost recovery of FSSM (N)	Requires close monitoring for regulatory compliance (N) Modification of sanitation codes and policy (Y)
INSTITUTIONAL IMPLICATIONS	ENVIRONMENTAL AND HEALTH IMPLICATIONS
Requires public sector involvement (Y) Requires private sector involvement (Y)	Reduces indiscriminate disposal of sludge (Y) Concerns of public health and environmental safety (N)
Y – Yes, P – Possible, N – No, NA – Not applicable	

## Summary

- There are multiple types of cost which need to be considered by setting up a FSTP.
- Selection of the technologies should be done after looking at LCC of the project.
- There are multiple transfers which happen when FSSM is operationalized.
- Selecting appropriate contracting and financial transfer model is key to sustainability of the FSSM.



Notes:

---

---

---

---

---

---

---

---

---

---

---

---

---

---

---

---

---

---

---

---

---

---

---



Download our latest reports, research briefs  
and training modules at:

[scbp.niua.org](http://scbp.niua.org)

#### About NIUA

NIUA is a premier national institute for research, capacity building and dissemination of knowledge in the urban sector, including sanitation. Established in 1976, it is the apex research body for the Ministry of Housing and Urban Affairs (MoHUA), Government of India. NIUA is also the strategic partner of the MoHUA in capacity building for providing single window services to the MoHUA/states/ULBs.

#### About SCBP

The Sanitation Capacity Building Platform (SCBP) is an initiative of the National Institute of Urban Affairs (NIUA) to address urban sanitation challenges in India. SCBP, supported by Bill & Melinda Gates Foundation (BMGF) is an organic and growing collaboration of credible national and international organisations, universities, training centres, resource centres, non-governmental organisations, academia, consultants and experts. SCBP supports national urban sanitation missions, states and ULBs, by developing and sourcing the best capacity building, policy guidance, technological, institutional, financial and behaviour change advice for FSSM. SCBP provides a unique opportunity for:

- Sharing and cross learning among the partner organisations, to pool in their knowledge resources on all aspects of urban sanitation capacity building;
- Developing training modules, learning and advocacy material including key messages and content, assessment reports and collating knowledge products on FSSM. Through its website ([scbp.niua.org](http://scbp.niua.org)), SCBP is striving to create a resource centre on learning and advocacy materials, relevant government reports, policy documents and case studies;
- Dissemination of FSSM research, advocacy and outreach to State governments and ULBs.

Its strength is its ability to bring together partners to contribute towards developing state sanitation policy, training of trainers and training content development, technical and social assessments, training programme delivery, research and documentation.



National Institute of Urban Affairs

### National Institute of Urban Affairs

1<sup>st</sup> Floor, Core 4B, India Habitat Centre, Lodhi Road, New Delhi - 110003  
Phone: 011-24617517, 24617543, 24617595, Fax: 011-24617513  
E-mail: [niua@niua.org](mailto:niua@niua.org) • Website: [www.niua.org](http://www.niua.org), [scbp.niua.org](http://scbp.niua.org)

